



2019



Elektrische Membranpumpen
Electric Diaphragm Pumps

4-9



Elektrische Kolbenpumpen
Electric Piston Pumps

10-11



Bodenmarkierung
Line Marking

12-13



Bautenschutz
Building Protection

14-15



Drucktanks, Pneumatik & Zubehör
Pressure tanks, Pneumatic & Accessories

18-35



Airless Spritzpistolen & Zubehör
Airless Spray Guns & Accessories

38-49



AirCombi & Elektrostatik Spritzpistolen
AirCombi & Electrostatic Spray Guns

50-53





Airless & AirCombi Düsensysteme
Airless & AirCombi Tip-Systems

54 - 65



Filtersysteme
Filter-Systems

66 - 77



Farbspritzschläuche
Paint Spray Hoses

78-83



Heißspritzsysteme
Hot Spray Systems

84-85



Luftpistolen - Spezialpistolen
Air Guns - Special Guns

86-93



Niederdruck Zubehör
Low Pressure Accessories

94-95



Reinigen
Cleaning

96-97

ORIGINAL. SPRAYMASTER.

Vorteile unserer Membranpumpen:

- EU-genormtes Anschlusskabel mit EU-Stecker (Gummi)
- Einlassventil mit Ventildrucker
- Ventilkegel made in Germany
- Manometer made in Germany mit lösemittelbeständigem Sicherheitsglas
- Flexibler Rücklauf inkl. Kugelhahn
- Neues verbessertes Auslassventil

Alle Pumpen sind von uns zusätzlich geprüft, eingestellt und auf ein **höheres, deutsches Qualitätsniveau** umgebaut.

Advantages of our Diaphragm Pumps:

- EU-standardized connection cable with EU-plug (rubber)
- Inlet valve with trigger
- Valve cone made in Germany
- Gauge set made in Germany with solvent resistant safety glass
- Flexible return pipe incl. ball valve
- New improved outlet valve

All pumps are rechecked, adjusted and modified to a **higher, German quality level**.



	A4000 PLUS	A5000 PLUS	A10000 PLUS
E-Motor <i>Electrical motor</i>	230 V / 50 Hz	230 V / 50 Hz	230 V / 50 Hz
Motorschutz-Schalter <i>Overload protection</i>	✓	✓	✓
Max. Düsengröße <i>Max. tip size</i>	0.021"	0.025"	0.031"
Freie Förderleistung <i>Free pump capacity</i>	4,5 Ltr./min.	5,5 Ltr./min.	6,5 Ltr./min.
Förderleistung (120 Bar) <i>Pump capacity (120 Bar)</i>	2,5 Ltr./min.	3,5 Ltr./min.	4,5 Ltr./min.
Gewicht (ohne Zubehör) <i>Weight (without accessories)</i>	22 kg	29 kg	46 kg
Max. Arbeitsdruck <i>Max. working pressure</i>	240 Bar	240 Bar	240 Bar

Außen- und Innendispersion, Grundierung, Latexfarben, Airless-Füller, Injektionsharze/-schaum, Lacke (Flammpunkt > 21°C), Holzschutz, Rostschutz, Betonsanierung, Desinfektion, uvm.

Emulsion paints for in- and outside, acrylic sealer, latex paints, airless-filler, injection resins/foam, varnish (flash point > 21°C), wood preservatives, rust protection, concrete refurbishment, disinfection liquids, and many more.

A4000 PLUS

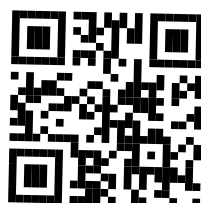

www.bit.ly/2CA4IWW



A10000 PLUS



www.bit.ly/2qndXPd

GEMINI. A4000 PLUS.



Alle Pumpen **auch in 110 Volt** lieferbar
 Aufpreis für **Edelstahlausführung 400,- € netto**
 Aufpreis für **Fahrwagen 200,- € netto**

All Pumps **also available in 110 Volt**
 Surcharge for **Stainless Steel Version 400,- € net**
 Surcharge for **Trolley Version 200,- € net**

1 BASIC

Pumpe **auf Tragegestell inkl. 6 ltr. Oberbehälter**
 komplett mit Filter und Rücklauf

Pump on Frame incl. 6 ltr. hopper
complete with Filter and Return Pipe



HD-Schlauch: 3/16" - 7,5 m - 1/4" NPS,
 Airless-Pistole: 250 Bar, Verpress-Set: 11/16"
 HP-Hose: 3/16" - 7,5 m - 1/4" NPS,
 Airless-Gun: 250 Bar, Injection set: 11/16"



HD-Schlauch: 3/16" - 7,5 m - 1/4" NPS,
 Pistole: 250 Bar, Filter: gelb
 Düse & Halter: UniTip - 415
 HP-Hose: 3/16" - 7,5 m - 1/4" NPS,
 Gun: 250 Bar, Filter: yellow
 Tip & Base: UniTip - 415



AC-Schlauch: 3/16" - 7,5 m - 1/4" NPS,
 Pistole: M100, Düse: 411 und Filter
 AC-Hose: 3/16" - 7,5 m - 1/4" NPS,
 Gun: M100, Tip: 411 and Filter

Spraymaster A4000 PLUS

Pos.	Art.-Nr. Part-No.	Artikelbeschreibung Description	Listenpreis	Netto-Stückpreis bei		
			List price	Net unit price for		
			€/Stück €/piece	1 Stück 1 piece	2 Stück 2 pieces	6 Stück 6 pieces
1	A4000H	Pumpe auf Tragegestell inkl. 6 ltr. Oberbehälter kpl. <i>Pump on frame incl. 6 ltr. hopper</i> cpl.	1.540,-			
2	A4000H-INJECT	SprayPack „Injection“	1.790,-			Auf Anfrage On request
3	A4000H-AL	SprayPack „Airless“				
4	A4000H-SS-AC	SprayPack „AirCombi“ - Edelstahl / Stainless Steel	2.580,-			

GEMINI. A5000 PLUS.

Alle Pumpen **auch in 110 Volt** lieferbar
 Aufpreis für **Edelstahlausführung** 400,- € netto
 Aufpreis **benzinbetriebene Version** 3.000,- € netto

All Pumps **also available in 110 Volt**
 Surcharge for **Stainless Steel Version** 400,- € net
 Surcharge for **Gasoline Version** 3.000,- € net



1 BASIC

Membranpumpe **auf Fahrwagen**
inklusive Manometerkombination

Diaphragm Pump on Trolley
including Gauge set



30 Liter Oberbehälter
 Schlauch: 1/4" - 15 m - 1/4" NPS, Pistole: 500 Bar
 Filter: weiß, Düse & Halter: UniTip - 421
 30 liters Hopper
 Hose: 1/4" - 15 m - 1/4" NPS, Gun: 500 Bar
 Filter: white, Tip & Base: UniTip - 421



Flexibles Ansaugsystem NW25
 Schlauch: 1/4" - 15 m - 1/4" NPS, Pistole: 500 Bar
 Filter: weiß, Düse & Halter: UniTip - 421
 Flexible suction system NW25
 Hose: 1/4" - 15 m - 1/4" NPS, Gun: 500 Bar
 Filter: white, Tip & Base: UniTip - 421

Spraymaster A5000 PLUS

Pos.	Art.-Nr. Part-No.	Artikelbeschreibung Description	Listenpreis List price	Netto-Stückpreis bei Net unit price for		
			€/Stück €/piece	1 Stück 1 piece	2 Stück 2 pieces	6 Stück 6 pieces
1	A5000	Pumpe auf Fahrwagen <i>Pump on Trolley</i>	1.950,-			
2	A5000-AL1	SprayPack „Airless 1“	2.460,-			Auf Anfrage On request
3	A5000-AL2	SprayPack „Airless 2“				

GEMINI. A10000 PLUS.

Alle Pumpen **auch in 110 Volt** lieferbar
 Aufpreis für **Edelstahlausführung 400,- € netto**
 Aufpreis **benzinbetriebene Version 3.000,- € netto**

All Pumps **also available in 110 Volt**
 Surcharge for **Stainless Steel Version 400,- € net**
 Surcharge for **Gasoline Version 3.000,- € net**



1 BASIC

Membranpumpe **auf Fahrwagen**
inklusive Manometerkombination

Diaphragm Pump on Trolley
including Gauge set

2

AIRLESS 1



30 Liter Oberbehälter
 Schlauch: 1/4" - 15 m - 1/4" NPS, Pistole: 500 Bar - 5 mm Kugel
 Filter: weiß, Düse & Halter: UniTip - 427

30 liters Hopper
 Hose: 1/4" - 15 m - 1/4" NPS, Gun: 500 Bar - 5 mm ball
 Filter: white, Tip & Base: UniTip - 427

3

AIRLESS 2



Flexibles Ansaugsystem NW25
 Schlauch: 1/4" - 15 m - 1/4" NPS, Pistole: 500 Bar - 5 mm Kugel
 Filter: weiß, Düse & Halter: UniTip - 427

Flexible suction system NW25
 Hose: 1/4" - 15 m - 1/4" NPS, Gun: 500 Bar - 5 mm ball
 Filter: white, Tip & Base: UniTip - 427

Spraymaster A10000 PLUS

Pos.	Art.-Nr. Part-No.	Artikelbeschreibung Description	Listenpreis	Netto-Stückpreis bei		
			List price	Net unit price for		
			€/Stück €/piece	1 Stück 1 piece	2 Stück 2 pieces	6 Stück 6 pieces
1	A10000	Pumpe auf Fahrwagen <i>Pump on Trolley</i>	2.360,-			
2	A10000-AL1	SprayPack „Airless 1“	2.790,-			Auf Anfrage On request
3	A10000-AL2	SprayPack „Airless 2“				



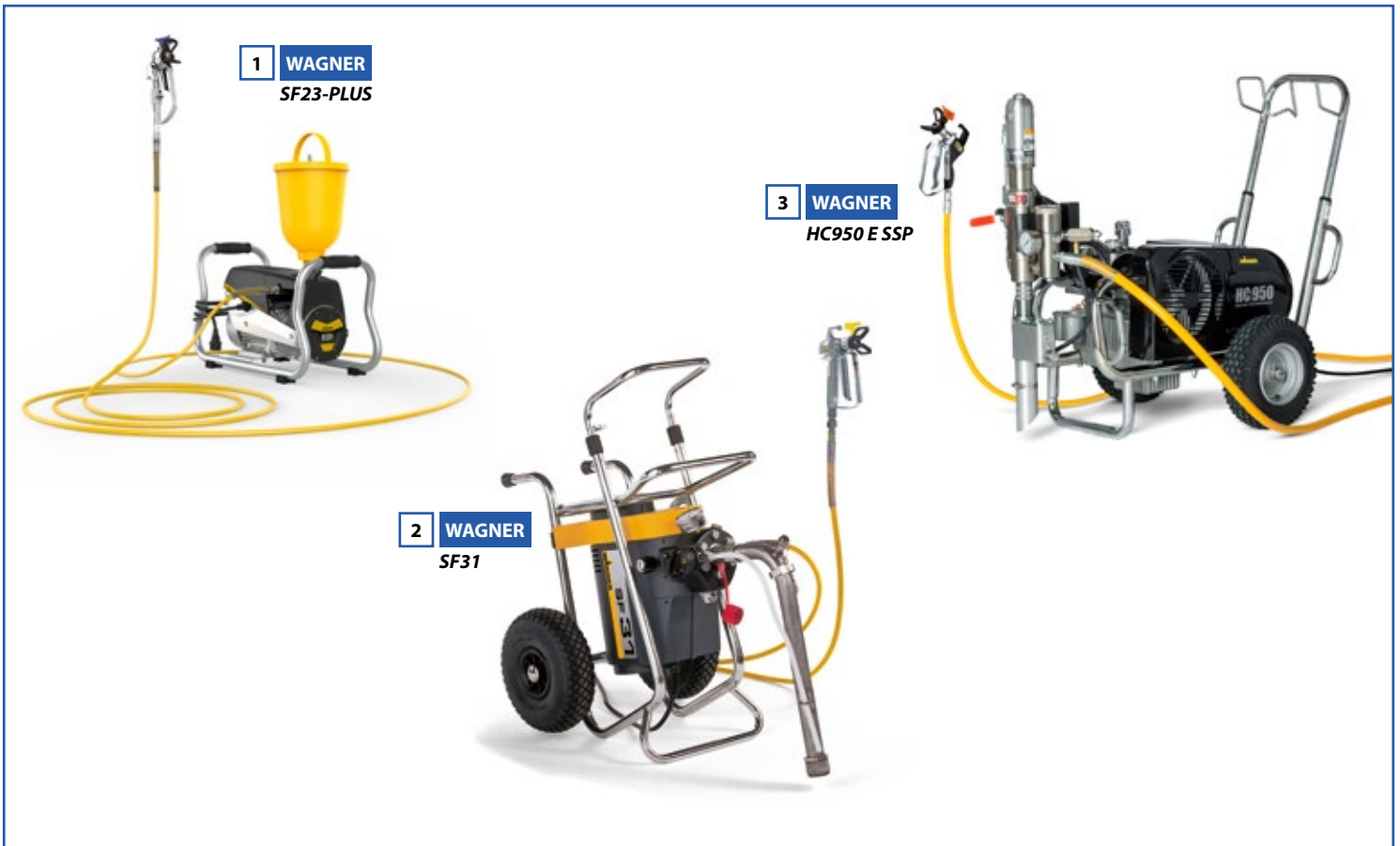

WAGNER

Pos.	Art.-Nr. Part-No.	Artikelbeschreibung Description	Listenpreis	Netto-Stückpreis bei		
			List price	Net unit price for		
			€/Stück €/piece	1 Stück 1 piece	2 Stück 2 pieces	6 Stück 6 pieces

SF23-PLUS

1	W2341491	SprayPack - Airless - Lack - auf Gestell <i>SprayPack - Airless - Lacquer - on frame</i>	3.125,-			Auf Anfrage <i>On request</i>
	W2341492	SprayPack - Airless - Lack - auf Fahrwagen <i>SprayPack - Airless - Lacquer - on trolley</i>	3.525,-			
	W2341494	SprayPack - Airless - Dispersion - auf Fahrwagen <i>SprayPack - Airless - Dispersion - on trolley</i>	3.350,-			
	W2341496	SprayPack - Airless - TempSpray - auf Fahrwagen <i>SprayPack - Airless - TempSpray - on trolley</i>	5.430,-			

SF31

2	W341022	SprayPack - Airless - Dispersion - auf Fahrwagen <i>SprayPack - Airless - Dispersion - on trolley</i>	6.275,-			Auf Anfrage <i>On request</i>
---	---------	--	---------	--	--	----------------------------------

HC950 E SSP

3	W2332187	SprayPack - Airless	9.250,-			Auf Anfrage <i>On request</i>
---	----------	---------------------	---------	--	--	----------------------------------

Weitere **Varianten und umfangreiches Zubehör für WAGNER** auf Anfrage
 Further **Versions and Extensive Range of Accessories for WAGNER** on request

ORIGINAL. GRACO. ASM.



	EP1900	EP2150	EP2550	EP3150	EP3750
E-Motor <i>Electrical motor</i>	230 V / 50 Hz	230 V / 50 Hz	230 V / 50 Hz	230 V / 50 Hz	230 V / 50 Hz
Max. Düsengröße <i>Max. tip size</i>	0.019"	0.021"	0.025"	0.031"	0.037"
Max. Förderleistung <i>Max. delivery rate</i>	1,5 Ltr./min.	1,8 Ltr./min.	2,5 Ltr./min.	3,6 Ltr./min.	4,5 Ltr./min.
Gewicht (ohne Zubehör) <i>Weight (without accessories)</i>	13 kg	17 kg	23 kg	43 kg	59 kg
Max. Arbeitsdruck <i>Max. working pressure</i>	207 Bar	230 Bar	230 Bar	230 Bar	230 Bar

1



2



ASM EP Series SprayPacks

Pos.	Art.-Nr. Part-No.	Artikelbeschreibung Description	Listenpreis	Netto-Stückpreis bei		
			List price	Net unit price for		
			€/Stück €/piece	1 Stück 1 piece	2 Stück 2 pieces	6 Stück 6 pieces
1	EP1900-SET SprayPack „Airless“	inkl. Ansaugsystem mit Filter, HD-Schlauch: 1/4" - 15 m Airless-Pistole: ASM500, Düsenhalter + Wendedüse: UNI Tip - 517 <i>incl. suction system with filter, HP-hose: 1/4" - 15 m Airless-Gun: ASM500, Tip base + Reversible tip: UNI Tip - 517</i>	1.260,-			Auf Anfrage On request
2	EP2150-SET SprayPack „Airless“	inkl. Ansaugsystem mit Filter, HD-Schlauch: 1/4" - 15 m Airless-Pistole: ASM500, Düsenhalter + Wendedüse: UNI Tip - 515 <i>incl. suction system with filter, HP-hose: 1/4" - 15 m Airless-Gun: ASM500, Tip base + Reversible tip: UNI Tip - 515</i>	2.060,-			Auf Anfrage On request



ASM EP Series SprayPacks

Pos.	Art.-Nr. Part-No.	Artikelbeschreibung Description	Listenpreis	Netto-Stückpreis bei		
			List price	Net unit price for		
			€/Stück €/piece	1 Stück 1 piece	2 Stück 2 pieces	6 Stück 6 pieces
1	EP2550-SET SprayPack „Airless“	inkl. Pumpenfilter: 60 Maschen, Ansaugsystem mit Filter HD-Schlauch: 1/4" - 15 m Airless-Pistole: ASM500, Düsenhalter + Wendedüse: UNI Tip - 517 <i>incl. pump filter: 60 mesh, suction system with filter HP-hose: 1/4" - 15 m Airless-Gun: ASM500, Tip base + Reversible tip: UNI Tip - 517</i>	2.790,-			Auf Anfrage On request
2	EP3150-SET SprayPack „Airless“	inkl. Pumpenfilter: 60 Maschen, Ansaugsystem mit Filter HD-Schlauch: 1/4" - 15 m Airless-Pistole: ASM500, Düsenhalter + Wendedüse: UNI Tip - 517 <i>incl. pump filter: 60 mesh, suction system with filter HP-hose: 1/4" - 15 m Airless-Gun: ASM500, Tip base + Reversible tip: UNI Tip - 517</i>	5.180,-			Auf Anfrage On request
3	EP3750-SET SprayPack „Airless“	inkl. Pumpenfilter: 60 Maschen, Ansaugsystem mit Filter HD-Schlauch: 3/8" - 15 m + Peitsche 1/4" - 1,5 m Airless-Pistole: ASM500, Düsenhalter + Wendedüse: UNI Tip - 517 + 535 <i>incl. pump filter: 60 mesh, suction system with filter HP-hose: 3/8" - 15 m + whip 1/4" - 1.5 m Airless-Gun: ASM500, Tip base + Reversible tip: UNI Tip - 517 + 535</i>	7.260,-			Auf Anfrage On request

Zubehör / Accessories

4	GR287987	Materialbehälter für Farbe und Spachtel <i>Material hopper for paint and plaster</i>	735,-			Auf Anfrage On request
5	GR289587	Sackpresse für Materialbehälter <i>Bag press for material hopper</i>	630,-			Auf Anfrage On request

NEW. PERFECT. POWRLINER™



	850	3500	6955
Max. Förderleistung <i>Max. delivery rate</i>	1,25 Ltr./min.	2,8 Ltr./min.	8,5 Ltr./min.
Max. Düsengröße <i>Max. tip size</i>	0.021" – 1 Gun	0.027" – 1 Gun	0.050" – 1 Gun 0.033" – 2 Guns
Max. Arbeitsdruck <i>Max. working pressure</i>	207 Bar	230 Bar	230 Bar
Gewicht (ohne Zubehör) <i>Weight (without accessories)</i>	38 kg	87 kg	140 kg
Motor <i>Engine</i>	37,7 cm ³ Viertaktmotor 4-Stroke Engine	3,0 kW (4 PS) – 120 cm ³ Honda Benzin Motor Honda Gas Engine	4,0 kW (5,5 PS) – 160 cm ³ Honda Benzin Motor Honda Gas Engine
	Einsteigermodell ideal für Sport- und Parkplatzmarkierung. <i>Entry level Unit especially for sports turfs and parking lots.</i>	Kompaktes Markiergerät für kleine bis mittlere Flächen. <i>Intermediate Unit for medium-size fields, pavement and turf.</i>	Allround Markiergerät für ein breites Einsatzspektrum. <i>Allround Marking Unit for a wide range of applications.</i>





1 850

Starter



www.bit.ly/2F7Dhet



3 6955

Allrounder



www.bit.ly/2n3pWx2



2 3500

Compact



www.bit.ly/2E1skf6



4 Side Striper

TITAN POWRLINER™

Pos.	Art.-Nr. Part-No.	Artikelbeschreibung Description	Listenpreis	Netto-Stückpreis bei		
			List price	Net unit price for		
			€/Stück €/piece	1 Stück 1 piece	2 Stück 2 pieces	6 Stück 6 pieces
850						
1	0290005 SprayPack	inkl. HD-Schlauch: 1/4" - 7,5 m, Airless-Pistole und Wendedüse <i>incl. HP-hose: 1/4" - 7.5 m, Airless-Gun and Reversible Tip</i>		Auf Anfrage <i>On request</i>		
3500						
2	0537015 SprayPack	inkl. HD-Schlauch: 1/4" - 15 m, Airless-Pistole und Wendedüse <i>incl. HP-hose: 1/4" - 15 m, Airless-Gun and Reversible Tip</i>		Auf Anfrage <i>On request</i>		
6955						
3	0290053 SprayPack	inkl. HD-Schlauch: 1/4" - 15 m, 2x Airless-Pistole und Wendedüse <i>incl. HP-hose: 1/4" - 15 m, 2x Airless-Gun and Reversible Tip</i>		Auf Anfrage <i>On request</i>		
Side Striper						
4	759150	Handmarkiergerät ohne Schlauch und Pistole <i>Manual Line Striper without Hose and Gun</i>		Auf Anfrage <i>On request</i>		

Weitere **Varianten und umfangreiches Zubehör** für TITAN auf Anfrage
Further Versions and Extensive Range of Accessories for TITAN on request

PERISTALTIC. PC30.

Für flüssige und pastöse **Materialien bis 2,5 mm**
Für **faserhaltige** Materialien
Für **nieder- und hochviskose** Materialien

For liquid and aggregated **materials up to 2,5 mm**
For materials **containing fibres**
For **low- and high viscosity** materials



1 **PC30**

Peristaltikpumpe **auf Fahrwagen**
mit 30 Liter Oberbehälter, ohne Kompressor

Peristaltic Pump on Trolley
with 30 liters hopper, without compressor



Pos.	Art.-Nr. Part-No.	Artikelbeschreibung Description	Listenpreis	Netto-Stückpreis bei		
			€/Stück €/piece	1 Stück 1 piece	2 Stück 2 pieces	6 Stück 6 pieces
PC30						
1	G-PC-30	Spraymaster PC30 auf Fahrwagen mit 30 ltr. Oberbehälter - ohne Kompressor <i>Spraymaster PC30 on trolley with 30 ltr. Hopper - without compressor</i>	3.590,-			Auf Anfrage <i>On request</i>

Zubehör / Accessories						
2	520030-30/50	Oberbehälter / Hopper - PC30 - 30 ltr.	164,-			

K330						
3	K330	Kompakt-Kompressor auf Wagen, 10 Bar - 330 ltr./min <i>Compact Compressor on trolley, 10 Bar - 330 ltr./min</i>				Auf Anfrage <i>On request</i>



Pos.	Art.-Nr. Part-No.	Artikelbeschreibung Description	Listenpreis	Netto-Stückpreis bei		
			List price	Net unit price for		
			€/Stück €/piece	1 Stück 1 piece	5 Stück 5 pieces	10 Stück 10 pieces

Zubehör / Accessories

1	PC30-104	Schwammkugel / <i>Sponge ball</i> - 20 mm	1,90			
2	PC30-105	Schwammkugel / <i>Sponge ball</i> - 30 mm	2,60			
3	FR-301	Trichterpistole inkl. Düsen 4/6/8 mm <i>Air Texture Hopper Gun incl. nozzles 4/6/8 mm</i>	129,-			

Spritzlanzen / Spray Lances

4	SPL-100-LB	Spritzlanze kpl. mit 6.5 mm Düse <i>Spray lance cpl. with 6.5 mm nozzle</i>	199,-			
5	SPL-330-LB	Spritzlanze kpl. mit 6.5 mm Düse - 330 mm <i>Spray lance cpl. with 6.5 mm nozzle - 330 mm</i>	206,-			

Düse für Spritzlanze / Nozzle for Spray Lance

6	78624	4.5 mm	36,-			
	78623	6.5 mm				
	78622	8.5 mm				
	78621	10.5 mm				
6	G-SPL-SET	Düsen-Set / <i>Nozzle-Set</i> 4.5/6.5/8.5/10.5 mm	144,-			
6	78625	Flachstrahl-Düse / <i>Flat-nozzle</i>	53,-			

NEW. PORTABLE. 4in1.



Tragegriff
Carrying handle

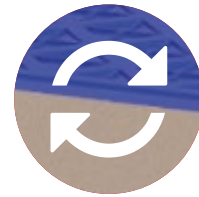

Wendearbeitsplatte
Reversible top panel



Anti-Rutsch Oberfläche
Non-slip surface



Höhenverstellbar
Adjustable height



1



Werkbank
Workbench

2



Arbeitsbühne
Scaffold

3



Rollwagen
Dolly

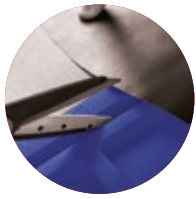

Schneidenut
Cutting groove

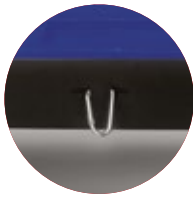

Befestigungsöse
Rope connector

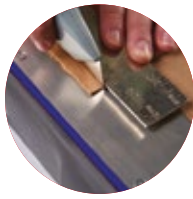

Stahlunterlage
Steel surface



Bohrvorrichtung
Drill hole



Winkelmesser
Protractor



Ablageschale
Storage tray

Multi-Table 4in1

Art.-Nr. Part-No.	Artikelbeschreibung Description	Netto-Stückpreis bei Net unit price for			
		5 Stück 5 pieces	10 Stück 10 pieces	30 Stück 30 pieces	
BL-4.0	<p>4in1 Tragbare Werkbank</p> <ul style="list-style-type: none"> - Leichtgewicht: nur 14,5 kg - Große Arbeitsfläche: ca. 95 x 46 cm - Tragfähigkeit: bis 150 kg - Höhenverstellbar: 3 Stufen <p>4in1 Portable Work Table</p> <ul style="list-style-type: none"> - Lightweight: only 14.5 kg - Large work surface area: ca. 95 x 46 cm - Load capacity: up to 150 kg - Adjustable height: 3 levels 	<p>Mindestabnahme: 1 Display = 5 Stück</p> <p>Minimum Order Quantity: 1 Display = 5 pieces</p>			Auf Anfrage On request

5 Einzelverpackungen
im Verkaufs-Display
5 single units in
practical Display

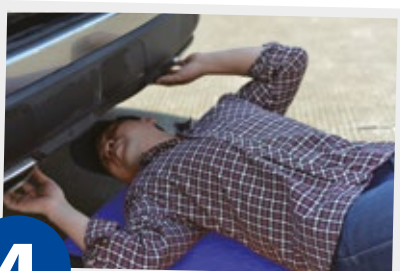

4

Rollbrett
Creeper



PRONA. TANKS.

Drucktanks in Aluminium und Edelstahl.

- Erhältlich in 2/5/10/20/40/60 Ltr.
- Mit pneumatischem, manuellem oder ohne Rührwerk
- Bis max. 3 Bar (mit Sicherheitsventil)
- Fahrbar durch einklappbare Räder
- Manometer für Materialspritzdruck

Pressure Tanks in Aluminium and Stainless Steel.

- Available in 2/5/10/20/40/60 Ltr.
- With pneumatic, manual or without Agitator
- Up to max. 3 Bar (with safety valve)
- Mobile by the use of folding tires
- Gauge for material pressure



**CE
ATEX**

Auf Anfrage • On request



E

ohne Rührwerk
without Agitator



A

mit pneumatischem Rührwerk
with pneumatic Agitator



M

mit manuellem Rührwerk
with manual Agitator

Drucktanks - Edelstahl / Pressure Tanks - Stainless Steel

Art.-Nr. Part-No.	Artikelbeschreibung Description	Listenpreis List price	Netto-Stückpreis bei Net unit price for		
		€/Stück €/piece	1 Stück 1 piece	5 Stück 5 pieces	10 Stück 10 pieces
RT-5ES	ohne Rührwerk / without Agitator - 5 Ltr.	510,-			
RT-5AS	mit pneumatischem Rührwerk / with pneumatic Agitator - 5 Ltr.	710,-			
RT-10ES	ohne Rührwerk / without Agitator - 10 Ltr.	990,-			
RT-10AS	mit pneumatischem Rührwerk / with pneumatic Agitator - 10 Ltr.	1.320,-			
RT-20AS	mit pneumatischem Rührwerk / with pneumatic Agitator - 20 Ltr.	1.540,-			
RT-40AS	mit pneumatischem Rührwerk / with pneumatic Agitator - 40 Ltr.	1.740,-			



PRONA

Art.-Nr. Part-No.	Artikelbeschreibung Description	Listenpreis List price	Netto-Stückpreis bei Net unit price for		
			€/Stück €/piece	1 Stück 1 piece	5 Stück 5 pieces

Drucktanks - Aluminium / Pressure Tanks - Aluminium

RT-2E	Aluminium - 2 Ltr. - Hakengriff / Handle Hook	154,-			
RC-2E	Aluminium - 2 Ltr. - Rundgriff / Handle round	198,-			
RT-5E	ohne Rührwerk / without Agitator - 5 Ltr.	299,-			
RT-5A	mit pneumatischem Rührwerk / with pneumatic Agitator - 5 Ltr.	460,-			
RT-10E	ohne Rührwerk / without Agitator - 10 Ltr.	480,-			
RT-10M	mit manuellem Rührwerk / with manual Agitator - 10 Ltr.	628,-			
RT-10A	mit pneumatischem Rührwerk / with pneumatic Agitator - 10 Ltr.	728,-			
RT-20E	ohne Rührwerk / without Agitator - 20 Ltr.	679,-			
RT-20M	mit manuellem Rührwerk / with manual Agitator - 20 Ltr.	790,-			
RT-20A	mit pneumatischem Rührwerk / with pneumatic Agitator - 20 Ltr.	898,-			
RT-40E	ohne Rührwerk / without Agitator - 40 Ltr.	790,-			
RT-40A	mit pneumatischem Rührwerk / with pneumatic Agitator - 40 Ltr.	980,-			
RT-60E	ohne Rührwerk / without Agitator - 60 Ltr.	840,-			
RT-60A	mit pneumatischem Rührwerk / with pneumatic Agitator - 60 Ltr.	1.190,-			

Einsatzbehälter - Edelstahl / Inner Tank - Stainless Steel

RT-IT-5-SS	5 Ltr.	88,-			
RT-IT-10-SS	10 Ltr.	98,-			
RT-IT-20-SS	20 Ltr.	104,-			
RT-IT-40-SS	40 Ltr.	124,-			
RT-IT-60-SS	60 Ltr.	152,-			

1 PRONA

- 1:1
- 3/8"
- 1/2"
- 1"
- 1,5"
- 2"



Edelstahl
Stainless Steel



Aluminium

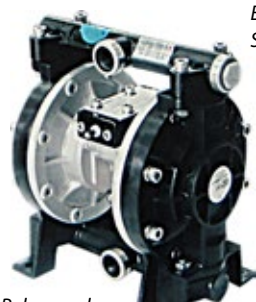

Polypropylene



**2 WAGNER
ZIP 52**

Doppelmembranpumpen / Double Diaphragm Pumps

Pos.	Art.-Nr. Part-No.	Artikelbeschreibung Description	Listenpreis List price	Netto-Stückpreis bei Net unit price for		
			€/Stück €/piece	1 Stück 1 piece	2 Stück 2 pieces	6 Stück 6 pieces
PRONA						
1	R-15	3/8" – 36 Ltr./min. – Aluminium	350,-			
	RS-15-SS	3/8" – 36 Ltr./min. – Edelstahl / stainless steel	520,-			
	R-20	1/2" – 50 Ltr./min. – Aluminium	490,-			
	RS-20-SS	1/2" – 50 Ltr./min. – Edelstahl / stainless steel	850,-			
	PP-20	1/2" – 50 Ltr./min. – Polypropylene	620,-			
	R-31	1" – 180 Ltr./min. – Aluminium	820,-			
	RS-31-SS	1" – 180 Ltr./min. – Edelstahl / stainless steel	1.640,-			
	R-41	1 1/2" – 300 Ltr./min. – Aluminium	1.490,-			
	RS-41-SS	1 1/2" – 300 Ltr./min. – Edelstahl / stainless steel	2.900,-			
	R-51	2" – 580 Ltr./min. – Aluminium	2.200,-			
	RS-51-SS	2" – 580 Ltr./min. – Edelstahl / stainless steel	5.090,-			

WAGNER ZIP						
2	U550.ATSS7	Zip 52 – Aluminium – ATSS7	764,-			Auf Anfrage On request
	U550.ATSS8	Zip 52 – Aluminium – ATSS8	819,-			
	U555.ATSS7	Zip 80 – Aluminium – ATSS7	973,-			

Weitere **SprayPacks & Varianten** auf Anfrage
Further **SprayPacks & Versions** on request



Doppelmembranpumpen / Double Diaphragm Pumps

Pos.	Art.-Nr. Part-No.	Artikelbeschreibung Description	Listenpreis List price	Netto-Stückpreis bei Net unit price for		
			€/Stück €/piece	1 Stück 1 piece	2 Stück 2 pieces	6 Stück 6 pieces
GRACO TRITON						
1	GR233500	3/8" - 32 Ltr./min. (20 DH/min.) - Aluminium	1.000,-	Auf Anfrage On request		
	GR233501-SS	3/8" - 32 Ltr./min. (20 DH/min.) - Edelstahl / stainless Steel	1.675,-			

PRONA R-15 Set						
2a	R-1500	R-15 Pumpe inkl. Filter & Ansaugsystem - Auf Ständer <i>R-15 Pump incl. filter & suction system - on stand</i>	398,-			
2b	R-1500-PLUS	R-15 Pumpe inkl. Filter, Ansaugsystem & Rührwerk - Auf Ständer <i>R-15 Pump incl. filter, suction system & agitator - on stand</i>	598,-			

Zubehör / Accessories						
3	R-T-DDP	Universal Fahrwagen inkl. Aufnahme für Doppelmembranpumpen <i>Universal trolley incl. support for Double Diaphragm Pumps</i>	179,-			
4	RPR-5	Materialdruckregler - 3/8" - 0-6 Bar - 2 Ltr./min. <i>Fluid regulator - 3/8" - 0-6 Bar - 2 Ltr./min.</i>	168,-			
5	RPR-5-SS	Materialdruckregler - 3/8" - 0-6 Bar - 2 Ltr./min. - Edelstahl <i>Fluid regulator - 3/8" - 0-6 Bar - 2 Ltr./min. - Stainless Steel</i>	278,-			

Umfangreiches **Zubehör für PRONA, WAGNER & GRACO** auf Anfrage
Extensive Range of Accessories for PRONA, WAGNER & GRACO on request

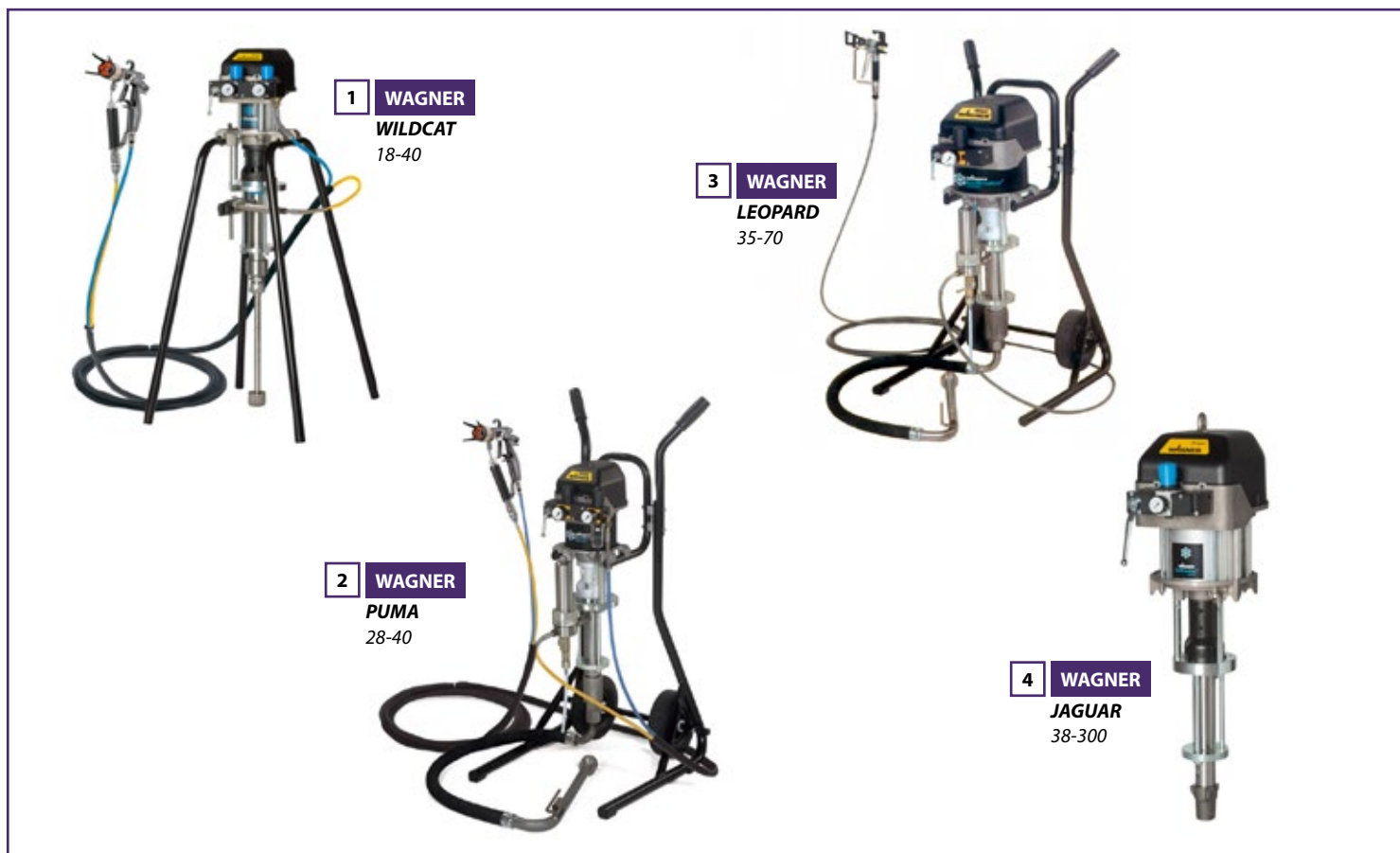

WAGNER

Pos.	Art.-Nr. Part-No.	Artikelbeschreibung Description	Listenpreis	Netto-Stückpreis bei		
			List price	Net unit price for		
			€/Stück €/piece	1 Stück 1 piece	2 Stück 2 pieces	6 Stück 6 pieces

WILDCAT 18-40

1	W2335090	Kolbenpumpe 18:40 PE/TG auf Gestell - ohne Zubehör <i>Piston Pump 18:40 PE/TG on frame - without accessories</i>	2.239,-			Auf Anfrage <i>On request</i>
	W2335177	Kolbenpumpe 18:40 PE/TG - SprayPack kpl. auf Fahrwagen - AirCoat - GM4700 <i>Piston Pump 18:40 PE/TG - SprayPack cpl. on trolley - AirCoat - GM4700</i>	3.104,-			

PUMA 28-40

2	W2335290	Kolbenpumpe 28:1 PE/TG auf Gestell - ohne Zubehör <i>Piston Pump 28:1 PE/TG on frame - without accessories</i>	3.453,-			Auf Anfrage <i>On request</i>
	W2335179	Kolbenpumpe 28:1 PE/TG - SprayPack kpl. auf Fahrwagen - AirCoat - GM4700 <i>Piston Pump 28:1 PE/TG - SprayPack cpl. on trolley - AirCoat - GM4700</i>	3.695,-			

LEOPARD 35-70

3	W2335182	Kolbenpumpe 35:1 - SprayPack kpl. auf Fahrwagen - Airless <i>Piston Pump 35:1 - SprayPack cpl. on trolley - Airless</i>	3.932,-			Auf Anfrage <i>On request</i>
---	----------	--	---------	--	--	----------------------------------

JAGUAR 38-300

4	W2329509	Kolbenpumpe 38:1 - ohne Zubehör <i>Piston Pump 38:1 - without accessories</i>	5.481,-			Auf Anfrage <i>On request</i>
---	----------	--	---------	--	--	----------------------------------

Weitere **SprayPacks & Varianten** auf Anfrage

Further **SprayPacks & Versions** on request



1 WAGNER
COBRA
40-10

2 WAGNER
COBRA
40-25

3 GRACO
MINI MERKUR
15:1
30:1

4 GRACO
MERKUR
10:1 - 48:1

Pos.	Art.-Nr. Part-No.	Artikelbeschreibung Description	Listenpreis List price	Netto-Stückpreis bei Net unit price for		
			€/Stück €/piece	1 Stück 1 piece	2 Stück 2 pieces	6 Stück 6 pieces
WAGNER COBRA 40-10						
1	W2342248	Pumpe auf Tragegestell mit Oberbehälter 5 ltr. inkl. Schlauchpaket 7.5 m • AirCoat Pistole GM4700 • Düse 411 <i>Pump on frame with hopper 5 ltr. incl. Hose-Set 7.5 m • AirCoat Gun GM4700 • Tip 411</i>	4.513,-			Auf Anfrage On request
WAGNER COBRA 40-25						
2	W2329525	Pumpe auf Gestell - ohne Zubehör <i>Pump on frame - without accessories</i>	4.753,-			Auf Anfrage On request
GRACO MINI MERKUR SprayPacks						
3	GR24F153	Pumpe auf Ständer - 30:1 - Edelstahl inkl. Schlauchpaket 7.5 m • G40-Pistole und Düse AAF <i>Pump on stand mount - 30:1 - Stainless Steel incl. Hose-Set 7.5 m • G40 Gun and Tip AAF</i>	2.229,-			Auf Anfrage On request
GRACO MERKUR						
4		Pumpen / Pumps - 10:1 - 48:1, Airless, AirCombi, Electrostatic		Auf Anfrage / On request		

GRACO. KING.

Airless-Spritzgeräte für **Schutzbeschichtungsanwendungen**. Das King-Gerät: voll ausgerüstet und bereit für **härteste Aufgaben**.

Airless Sprayers for Protective Coating Applications. The King fully loaded and ready to tackle your toughest job.



1 KING

SprayPack inklusive Filter, Schlauch 15 m mit Schlauchpeitsche, XTR-Pistole und XHD-Düse

SprayPack inclusive Filter, Hose 15 m with Hose Whip, XTR-Gun and XHD-Tip



GRACO KING

Pos.	Art.-Nr. Part-No.	Artikelbeschreibung Description	Listenpreis List price	Netto-Stückpreis bei Net unit price for		
			€/Stück €/piece	1 Stück 1 piece	2 Stück 2 pieces	6 Stück 6 pieces
1	K45FH1	Pumpe 45:1 auf Fahrwagen Pump 45:1 on trolley	6.144,-			Auf Anfrage On request
	K60FH1	Pumpe 60:1 auf Fahrwagen Pump 60:1 on trolley				
	K70FH1	Pumpe 70:1 auf Fahrwagen Pump 70:1 on trolley				
	K90FH1	Pumpe 90:1 auf Fahrwagen Pump 90:1 on trolley				

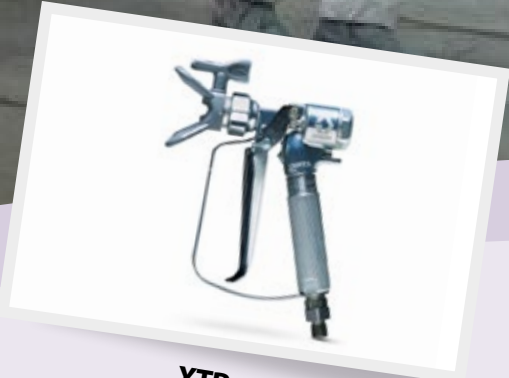

XTR
Seite / Page 41



XHD
Seite / Page 62



PRONA

Pos.	Art.-Nr. Part-No.	Artikelbeschreibung Description	Listenpreis	Netto-Stückpreis bei		
			List price	Net unit price for		
			€/Stück €/piece	1 Stück 1 piece	3 Stück 3 pieces	5 Stück 5 pieces

Pneumatische Rührwerke / Pneumatic Agitators

1	RB-MN	Mini Rührwerk - max. 10 Ltr. Gebinde <i>Mini agitator - max. 10 ltr. compound units</i>	238,-			
2	RB-MN-1A	Mini Rührwerk - max. 10 Ltr. Gebinde - inkl. Universal Adapter <i>Mini agitator - max. 10 ltr. compound units - incl. universal adapter</i>	258,-			
3	RB-MA	Mobiles Handrührwerk - max. 30 Ltr. Gebinde <i>Mobile hand agitator - max. 30 ltr. compound units</i>	299,-			
4	RB-200-KLEMM	Rührwerk inkl. Klemmbefestigung - 200 Ltr. Gebinde <i>Agitator with clamp fixation - 200 ltr. compound units</i>	268,-			
5	RB-200-FIX	Rührwerk mit FIX Befestigung - 200 Ltr. Gebinde <i>Agitator with fixation - 200 ltr. compound units</i>	268,-			

Luftmotoren / Air Motors

6	RB-M10	M10 - 60 Watt - 2.200 U./min. / 2.200 RPM	169,-			
	RB-M20	M20 - 120 Watt - 3.000 U./min. / 3.000 RPM	189,-			
	RB-M30	M30 - 190 Watt - 2.500 U./min. / 2.500 RPM	209,-			
	RB-M40	M40 - 300 Watt - 2.100 U./min. / 2.100 RPM	379,-			
	RB-M50	M50 - 370 Watt - 1.420 U./min. / 1.420 RPM	499,-			

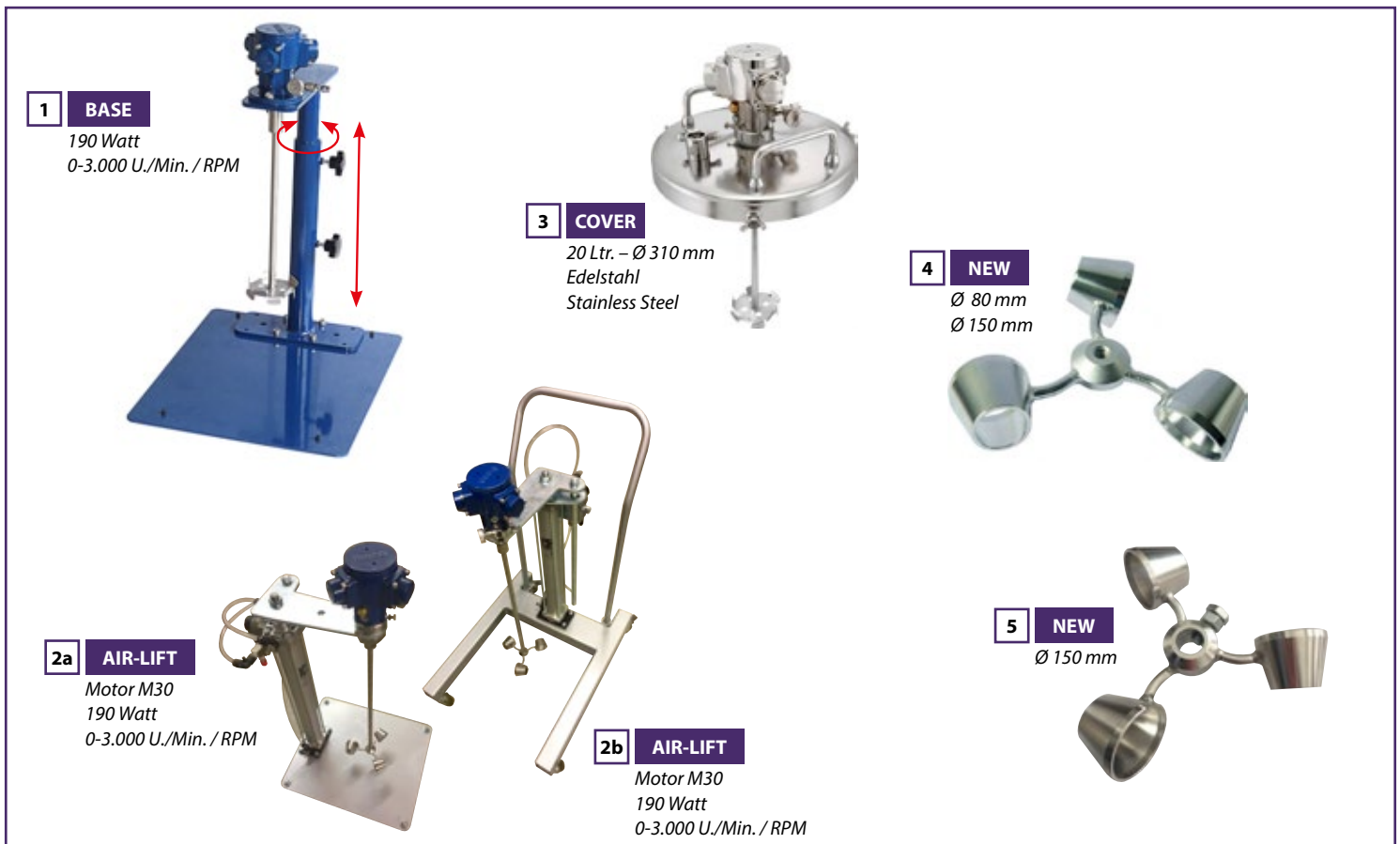

1 BASE
190 Watt
0-3.000 U./Min. / RPM

3 COVER
20 Ltr. - Ø 310 mm
Edelstahl
Stainless Steel

4 NEW
Ø 80 mm
Ø 150 mm

2a AIR-LIFT
Motor M30
190 Watt
0-3.000 U./Min. / RPM

2b AIR-LIFT
Motor M30
190 Watt
0-3.000 U./Min. / RPM

5 NEW
Ø 150 mm

PRONA

Pos.	Art.-Nr. Part-No.	Artikelbeschreibung Description	Listenpreis	Netto-Stückpreis bei		
			List price	Net unit price for		
			€/Stück	1 Stück	3 Stück	5 Stück
			€/piece	1 piece	3 pieces	5 pieces

Pneumatische Rührwerke / Pneumatic Agitators

1	RB-BA	Rührwerk Station kpl. - max. 30 Ltr. Gebinde Agitator Base cpl. - max 30. ltr. compound units	378,-			
2a	RB-BA-AIR	Pneum. Rührwerk Station kpl. - max. 30 Ltr. Gebinde - auf Bodenplatte Pneum. Agitator Base cpl. - max 30. ltr. compound units - on Fixed Plate	790,-			
2b	RB-BA-AIR-T	Pneum. Rührwerk Station kpl. - max. 30 Ltr. Gebinde - auf Fahrwagen Pneum. Agitator Base cpl. - max 30. ltr. compound units - on Trolley	980,-			
3	RB-COVER-20	Deckeleinheit inkl. Rührwerk - 20 Ltr. Gebinde - Ø 310 mm - Edelstahl Cover unit with agitator - 20 ltr. compound units - Ø 310 mm - stainless steel	386,-			
			€/Stück	1 Stück	5 Stück	10 Stück
			€/piece	1 piece	5 pieces	10 pieces

Rührflügel / Mixing Propeller

4	RFD80	Rührflügel - Edelstahl / Propeller - Stainless Steel - Ø80 - M8	130,-			
	RFD150	Rührflügel - Edelstahl / Propeller - Stainless Steel - Ø150 - M8	154,-			
5	RFD150-2	Rührflügel Ø150 - Edelstahl - ohne Gewinde - mit Fixierschraube - Ø Loch 12 mm Propeller - Ø150 - Stainless Steel - without threading - with fixation - Ø hole 12 mm	154,-			
	RFD150-3	Rührflügel Ø150 - Edelstahl - ohne Gewinde - mit Fixierschraube - Ø Loch 15 mm Propeller - Ø150 - Stainless Steel - without threading - with fixation - Ø hole 15 mm				

Weitere Nippel auf Seite 83
Further Nipples on page 83

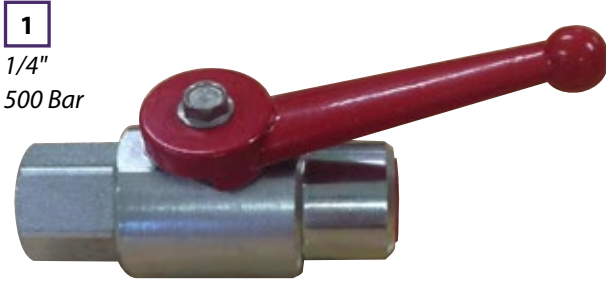

1
1/4"
500 Bar



3
500 Bar

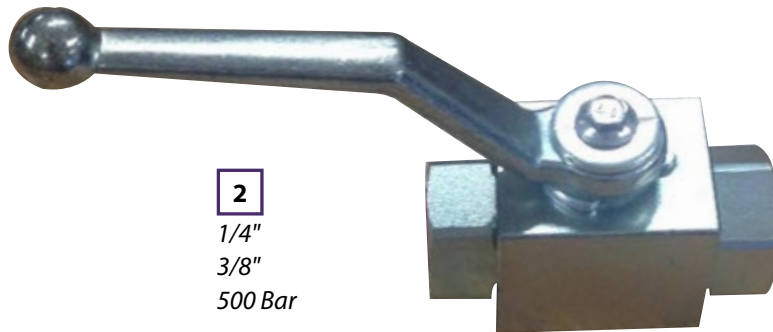

2
1/4"
3/8"
500 Bar

Pos.	Art.-Nr. Part-No.	Artikelbeschreibung Description	Listenpreis	Netto-Stückpreis bei		
			List price	Net unit price for		
			€/Stück €/piece	1 Stück 1 piece	5 Stück 5 pieces	10 Stück 10 pieces

Hochdruck Kugelhähne / High Pressure Ball Valves - 500 bar

1	23010-K-B	G 1/4" BSP - Klein / Small	32,-			
	23010-K-N	1/4" NPS - Klein / Small	18,-			
	23010-K-B-SS	G 1/4" BSP - Klein Edelstahl / Small Stainless Steel	54,-			
	23010-K-N-SS	1/4" NPS - Klein Edelstahl / Small Stainless Steel	34,-			
2	23010-G-B	G 1/4" BSP - Groß / Big	32,-			
	23015-G-N	3/8" NPS - Groß / Big	32,-			
	23010-G-B-SS	G 1/4" BSP - Groß Edelstahl / Big Stainless Steel	86,-			
	23010-G-N-SS	1/4" NPS - Groß Edelstahl / Big Stainless Steel	54,-			
	23015-G-B-SS	G 3/8" BSP - Groß Edelstahl / Big Stainless Steel	119,-			
	23015-G-N-SS	3/8" NPS - Groß Edelstahl / Big Stainless Steel	66,-			

Hochdruck Verbindungsrippel / High Pressure Nipples - 500 Bar

			€/Stück €/piece	1 Stück 1 piece	10 Stück 10 pieces	25 Stück 25 pieces
3	M1/4BXM1/4B	1/4" BSP (M) x 1/4" BSP (M)	4,40			
	M1/4NXM1/4N	1/4" NPS (M) x 1/4" NPS (M)				
3	M1/4BXM1/4B-SS	1/4" BSP (M) x 1/4" BSP (M) - SS	10,-			
	M1/4NXM1/4N-SS	1/4" NPS (M) x 1/4" NPS (M) - SS				
3	M3/8NXM3/8N	3/8" NPS (M) x 3/8" NPS (M)	7,50			
	M3/8NXM3/8N-SS	3/8" NPS (M) x 3/8" NPS (M) - SS	10,-			

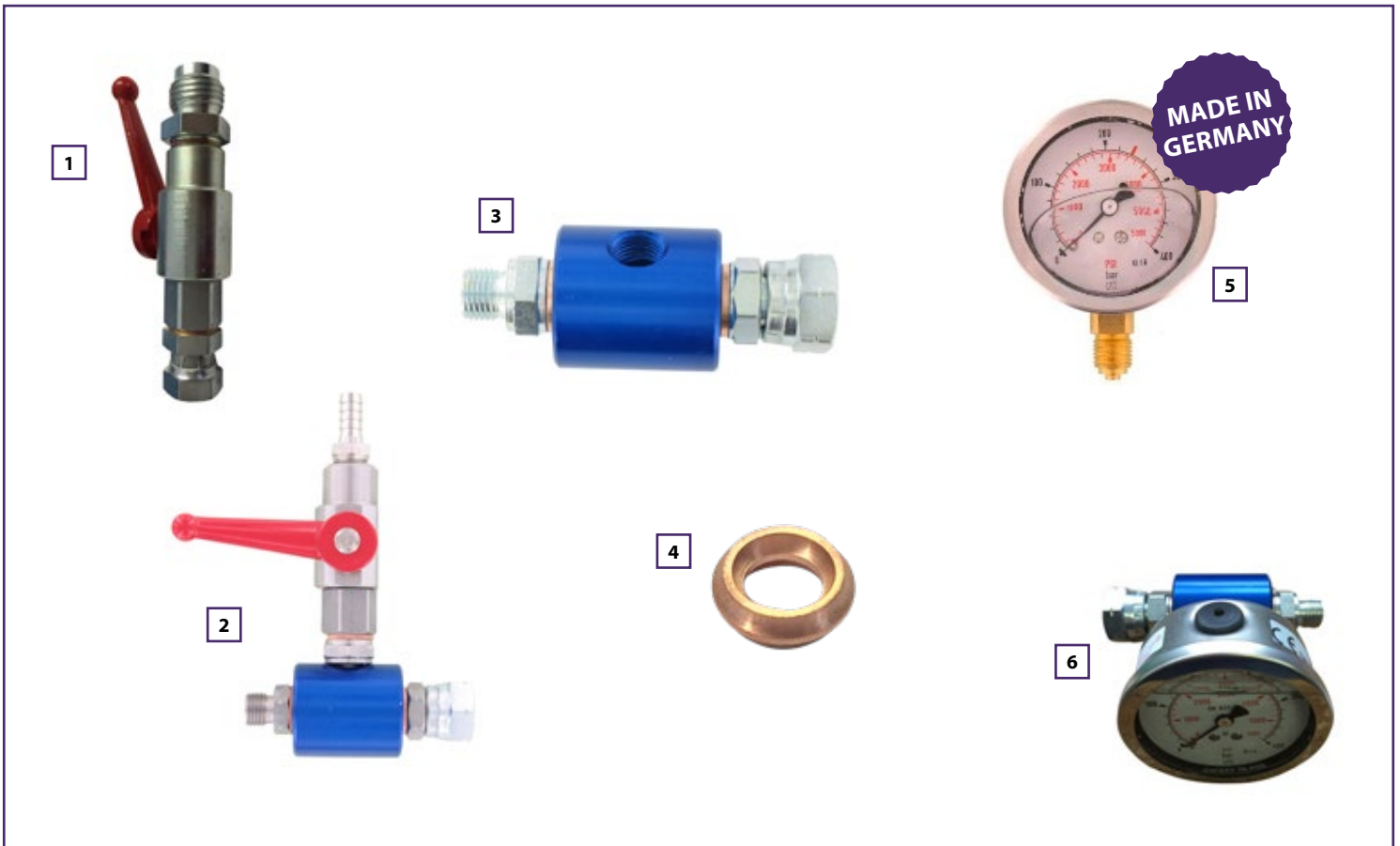

Pos.	Art.-Nr. Part-No.	Artikelbeschreibung Description	Listenpreis List price	Netto-Stückpreis bei Net unit price for		
			€/Stück €/piece	1 Stück 1 piece	5 Stück 5 pieces	10 Stück 10 pieces

Hochdruck Kugelhähne / High Pressure Ball Valves - 500 bar

1	CA5123	1/4" (F) x M20x2 (M) - A4000-A10000	44,-			
	CA5123-SS	1/4" (F) x M20x2 (M) - SS - A4000-A10000	66,-			
2	KH-SET	Ablass-Kugelhahn-Set / Drain-ballvalve-set	140,-			

Manometer / Gauges

3	MA-1/4-KPL	Manometeraufnahme / Connection for gauge - 1/4" NPS	20,-			
	MA-1/4-KPL-SS	Manometeraufnahme / Connection for gauge - 1/4" NPS - SS	39,-			
	MA-M16-KPL	Manometeraufnahme / Connection for gauge - M16x1.5	20,-			
	MA-M16-KPL-SS	Manometeraufnahme / Connection for gauge - M16x1.5 - SS	39,-			
4	MANO-DI	Profildichtung für Manometer / Profile Seal for Gauge	0,90			
5	MM50A	Ø50 axial	40,-			
	MM63R	Ø63 radial				
	MM63A	Ø63 axial				
6	MK1/4KPL	Manometer Set kpl. / Gauge set cpl. - 1/4" NPS	66,-			
	MK1/4KPL-SS	Manometer Set kpl. / Gauge set cpl. - 1/4" NPS - SS	88,-			
	MKF16XM1/4	Manometer Set kpl. / Gauge set cpl. - M16(F) x 1/4" NPS(M)	66,-			



Pos.	Art.-Nr. Part-No.	Artikelbeschreibung Description	Listenpreis	Netto-Stückpreis bei		
			€/Stück €/piece	1 Stück 1 piece	5 Stück 5 pieces	10 Stück 10 pieces

HD-Filtergehäuse / HP Filter Housing - 500 Bar

1	HP-FI-LO-N	3/8" NPS (F) - 1/4" NPS (M) - Edelstahl / Stainless Steel	164,-			
---	------------	---	-------	--	--	--

HD-Adapter / HP Adapter - 500 Bar

			€/Stück €/piece	1 Stück 1 piece	10 Stück 10 pieces	25 Stück 25 pieces
2	M1/4Nx3/8N-SS	1/4" NPS (M) x 3/8" NPS (F) - Edelstahl / Stainless Steel	10,-			
	M1/4Nx16-SS	1/4" NPS (M) x M16x1.5 (F) - Edelstahl / Stainless Steel				
weitere Adapter auf Seite 48 / further Adapters on page 48						

HD-Nippel / HP Nipple - 500 Bar

			€/Stück €/piece	1 Stück 1 piece	10 Stück 10 pieces	25 Stück 25 pieces
3	M1/4NxM1/4N-SS	1/4" NPS (M) x 1/4" NPS (M) - Edelstahl / Stainless Steel	10,-			
	M1/4NxM3/8N-SS	1/4" NPS (M) x 3/8" NPS (M) - Edelstahl / Stainless Steel				
	M1/4NxM16-SS	1/4" NPS (M) x M16x1.5 (M) - Edelstahl / Stainless Steel				
weitere Nippel auf Seite 83 / further Nipples on page 83						

Filter & Stützkörper auf den Seiten 70/71

Filters & Supports on pages 70/71

1 THROAT SEALING LIQUID

Trennmittel
Separating Fluid
500 ml



2 ASM THROAT SEALING LIQUID

Trennmittel
Separating Fluid
240 ml



3 ASM PUMP LIFE

Konservierungsmittel
Preserving Agent
1.000 ml

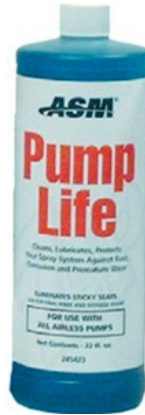

4 ASM

Hydrauliköl
Hydraulic Fluid
1.000 ml

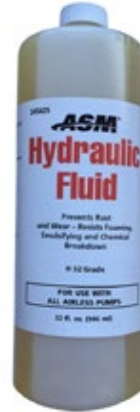

5 ASM

Starter-Kit



Pos.	Art.-Nr. Part-No.	Artikelbeschreibung Description	Listenpreis	Netto-Stückpreis bei		
			List price	Net unit price for		
			€/Stück €/piece	1 Stück 1 piece	5 Stück 5 pieces	10 Stück 10 pieces

Flüssigkeiten & Konservierungsmittel / Fluids & Preserving Agents

1	TM05	Trennmittel für Kolbenpumpen - 500 ml <i>Separating fluid for piston pumps - 500 ml</i>	9,80			
2	GR245427	ASM Trennmittel für Kolbenpumpen - 240 ml <i>ASM Separating fluid for piston pumps - 240 ml.</i>	19,-			
3	GR245423	ASM Pump Life Konservierungsmittel - 1.000 ml <i>ASM Pump Life preserving agent - 1.000 ml</i>				
4	GR245425	ASM Hydrauliköl - 1.000 ml / <i>ASM hydraulik oil - 1.000 ml</i>	19,-			
5	GR245651	ASM Starter-Kit Packing-Seal - 120 ml Pump Life - 240 ml Für alle Airless-Geräte / <i>For use with all Airless Paint Sprayers</i>	34,-			



Reinigungs-Sets Seite 97
Cleaning Sets page 97



Düsenreinigung Seite 96
TIP-Cleaning page 96



Reinigungsnadeln Seite 96
Cleaning broaches page 96



Oberbehälter / Hoppers

Pos.	Art.-Nr. Part-No.	Artikelbeschreibung Description	Listenpreis	Netto-Stückpreis bei		
			List price	Net unit price for		
			€/Stück €/piece	1 Stück 1 piece	5 Stück 5 pieces	10 Stück 10 pieces
6 Liter						
1	520001-TRANS	Oberbehälter mit Deckel / Hopper with lid - M36x2 - transparent	49,-			
2	520001-EX	Oberbehälter mit Deckel / Hopper with lid - M36x2 - ATEX - schwarz / black	64,-			
3	RL-6	Rücklauf / Return pipe - M20x2	54,-			
	RL-6-W-LB	Rücklauf passend WAGNER / Return pipe fitting WAGNER	54,-			
4	520001-SS	Oberbehälter mit Deckel - Edelstahl - M36x2 Hopper with lid - stainless steel - M36x2	350,-			

30 Liter						
5	520030-M36	Oberbehälter mit Deckel / Hopper with lid - M36x2	139,-			
6	RL-30	Rücklauf / return pipe	68,-			

Zubehör / Accessories			€/Stück €/piece	1 Stück 1 piece	10 Stück 10 pieces	30 Stück 30 pieces
7	FI-HÜ	Filterscheibe 20 Maschen / Filter disc 20 mesh - D87 (6 ltr.)	2,50			
	FD-59-XXX-LB	Filterscheibe Edelstahl 20/50 Maschen - D59 (30 ltr.) Filter disc stainless steel 20/50 mesh - D59 (30 ltr.)	3,-			

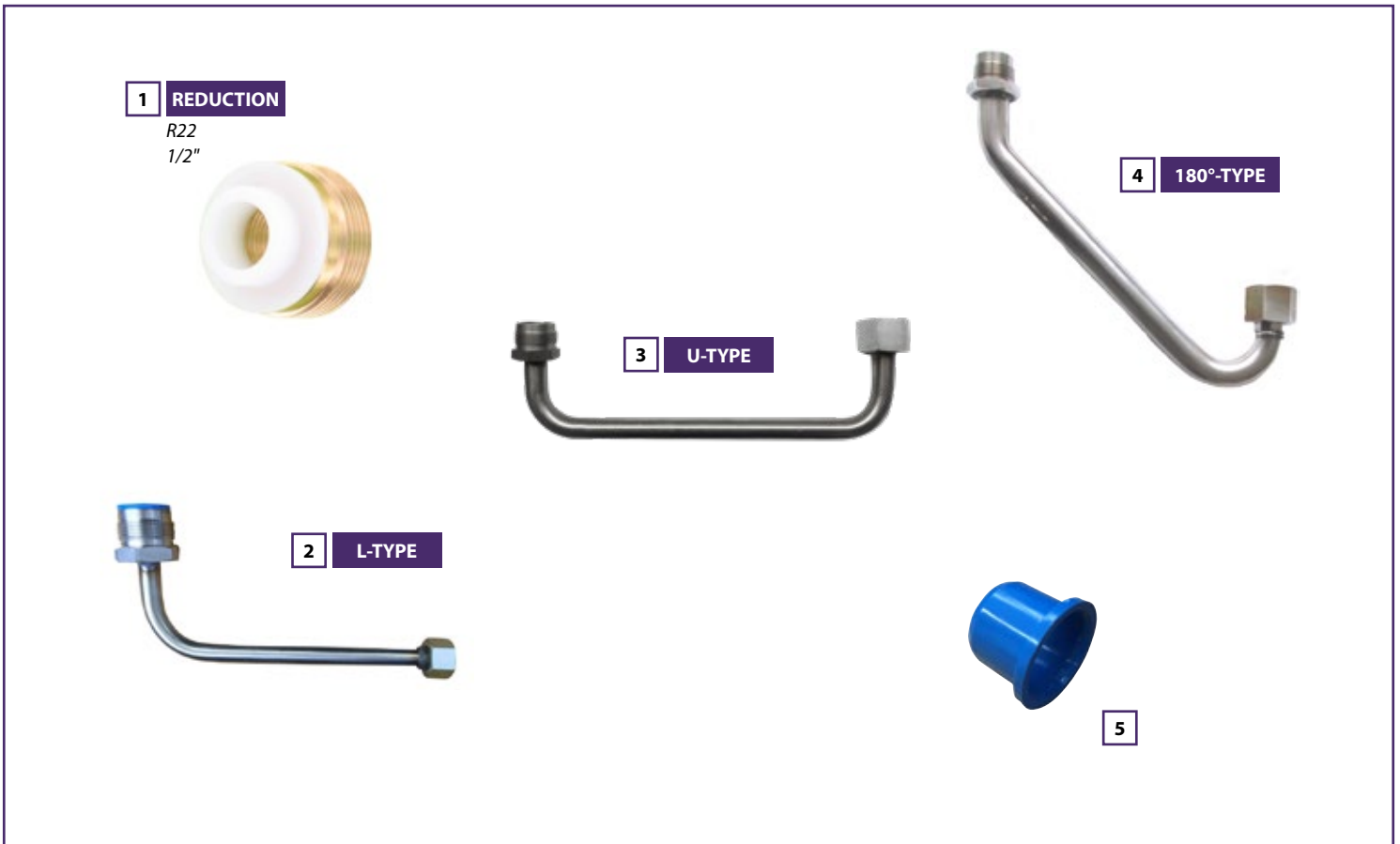

Oberbehälter / Hoppers

Pos.	Art.-Nr. Part-No.	Artikelbeschreibung Description	Listenpreis	Netto-Stückpreis bei		
			List price	Net unit price for		
			€/Stück €/piece	1 Stück 1 piece	5 Stück 5 pieces	10 Stück 10 pieces

Zubehör / Accessories

1	ZR-R22	Zwischenring für Reduktion / Adapter for reduction - R22	10,-			
	ZR-1/2	Zwischenring für Reduktion / Adapter for reduction - 1/2"				
	DS-R22	Dichtscheibe für Reduktion / Seal plate for reduction - R22	5,90			
	DS-1/2	Dichtscheibe für Reduktion / Seal plate for reduction - 1/2"				

Ansaugbögen Edelstahl / Suction-Adapters Stainless Steel

2	SUC-L-1/2-SS	L-Ansaugbogen / L-Suction-Adapter - M36x2 x 1/2"	36,-			
3	SUC-U-1/2-SS	U-Ansaugbogen / U-Suction-Adapter - M36x2 x 1/2"	44,-			
	SUC-U-3/4-SS	U-Ansaugbogen / U-Suction-Adapter - M36x2 x 3/4"				
	SUC-U-M36-SS	U-Ansaugbogen / U-Suction-Adapter - M36x2 x M36x2				
4	SUC-180-3/4-SS	180°-Ansaugbogen / 180°-Suction-Adapter - M36x2 x 3/4"	49,-			
	SUC-180-M36-SS	180°-Ansaugbogen / 180°-Suction-Adapter - M36x2 x M36x2				
	SUC-180-M26-SS	180°-Ansaugbogen / 180°-Suction-Adapter - M36x2 x M26x1,25				
5	SUC-GASKET	Dichtung für Ansaugbogen / Gasket for Suction-Adapter	3,90			



Flexible Ansaugsysteme / Flexible Suction Systems

Pos.	Art.-Nr. Part-No.	Artikelbeschreibung Description	Listenpreis	Netto-Stückpreis bei		
			List price	Net unit price for		
			€/Stück €/piece	1 Stück 1 piece	5 Stück 5 pieces	10 Stück 10 pieces

Gerade Edelstahl / Straight Stainless Steel - M36x2

1+2	NW13-VA-KPL	Ø13 Ansaugsystem kpl. / suction system cpl. - Filter M15	117,-			
	NW13AS-VA	Ø13 Ansaugschlauch / suction hose	59,-			
	NW19-VA-KPL	Ø19 Ansaugsystem kpl. / suction system cpl. - Filter 1/2"	120,-			
	NW19AS-VA	Ø19 Ansaugschlauch / suction hose	63,-			
	NW25-VA-KPL	Ø25 Ansaugsystem kpl. / suction system cpl. - Filter M28	126,-			
	NW25AS-VA	Ø25 Ansaugschlauch / suction hose	67,-			

90° Edelstahl / 90° stainless steel - M36x2

3+4	NW13KPL-90-VA	Ø13 Ansaugsystem kpl. / suction system cpl. - Filter M15	127,-			
	NW13AS-90-VA	Ø13 Ansaugschlauch / suction hose	62,-			
	NW19KPL-90-VA	Ø19 Ansaugsystem kpl. / suction system cpl. - Filter 1/2"	131,-			
	NW19AS-90-VA	Ø19 Ansaugschlauch / suction hose	67,-			
	NW25KPL-90-VA	Ø25 Ansaugsystem kpl. / suction system cpl. - Filter M28	139,-			
	NW25AS-90-VA	Ø25 Ansaugschlauch / suction hose	74,-			

Rücklaufschläuche / Return Hoses - M20x2

5	NW-RS-VA	gerade / straight	46,-			
	NW-RS-90-VA	90°	49,-			

Weitere **Anschlussgewinde und Längen** auf Anfrage
Further **connections and lengths** on request

1 HEXAGON



3 MINI
Ø 27 mm
H: 31 mm



4 LowBudget
Ø 22 mm / Ø 28 mm
H: 130 mm



2 ROUND

5 LowBudget

Filter 100 Maschen/Mesh
& 50 Maschen/Mesh



Ansaugfilter / Suction Filters

Pos.	Art.-Nr. Part-No.	Artikelbeschreibung Description	Listenpreis List price	Netto-Stückpreis bei Net unit price for		
			€/Stück €/piece	1 Stück 1 piece	10 Stück 10 pieces	30 Stück 30 pieces
1	AF-H-15-XXX	15 Maschen / 15 Mesh - 1/2" / 3/4" / 1" / M28 / M38 - Hexagon	18,-			
	AF-H-30-XXX	30 Maschen / 30 Mesh - M15 / M28 - Hexagon				
2	ANF-R-15-XXX	15 Maschen / 15 Mesh - 1/2" / 3/4" / 1" / M15 / M28 - Round	10,-			
	ANF-R-30-XXX	30 Maschen / 30 Mesh - 1/2" / 3/4" / 1" / M15 / M28 / M38 - Round				
	ANF-R-60-XXX	60 Maschen / 60 Mesh - 1/2" / M15 / M28 - Round				
3	ANF-MINI-1/2	30 Maschen / 30 Mesh - 1/2"	10,-			
	ANF-MINI-M15	30 Maschen / 30 Mesh - M15				
4	2011101	grob / rough - Ø 28	20,-			
	2011102	fein / smooth - Ø 28				
	2011103	grob / rough - Ø 22				
	2011104	fein / smooth - Ø 22				
5	FG-KPL-M15-LB	Filterglocke kpl. / Filter housing cpl. - M15x1	5,-			
	FG-KPL-1/2-LB	Filterglocke kpl. / Filter housing cpl. - 1/2"				

SOLVENT. RECOVERY. SYSTEM.



PRICE ON
REQUEST



PRICE ON
REQUEST

Geld sparen durch Lösemittel-Recycling!

- Explosionsgeschützt / ATEX geprüft
- Zum Recyclen von entflammaren und nicht entflammaren Lösemitteln
- Ladekapazität: 15 / 30 / 60 / 120 Liter
- Stromspannung: 230 V - 50 Hz
- Elektrischer Anschluss: Einphasig & Erdung
- Elektrische Sicherung: II2G IIA T3 bis T2
- Dampfkondensator: Edelstahl – Luftgekühlt
- Kein Verkauf innerhalb Deutschlands

Recover Solvent - Safe Money!

- Explosion proof version / ATEX approved
- For recycling of flammable and not flammable solvents
- Loading capacity: 15 / 30 / 60 / 120 litres
- Voltage: 230 V - 50 Hz
- Electrical supply: single phase & earth
- Electrical protection: II2G IIA T3 to T2
- Vapour condenser: stainless steel – cooled by air
- No sales to Germany

PROCONTRACTOR. HVLP.

1 FinishPro 9.5

- Ideale Spritzgeräte für kleine bis mittelgroße Anwendungen
- Bietet ausgezeichnete Lebensdauer mit SmartStart
- Ausgestattet mit Funktionen für Benutzerkomfort, Regelung und hervorragende Sprühdeckung
- *Ideal sprayer for small-to-medium jobs*
- *Offers unmatched life with SmartStart*
- *Loaded with features that offer convenience, control and produce a superior spray finish*

WEITERE
VARIANTEN
AUF ANFRAGE

FURTHER
VERSIONS
ON REQUEST



CORDLESS. ULTRAMAX.

2 ULTRAMAX

- Airless-Handspritzgerät ohne Kabel
- Für lösungsmittel- und wasserbasierte Materialien
- inkl. 2 Akkus und 2 FFLP Wendedüsen (410 / 514)
- *Cordless Airless Handheld*
- *Solvent and waterbased materials compatible*
- *incl. 2 Batteries and 2 FFLP Reversible Tips (410/514)*



GRACO

Pos.	Art.-Nr. Part-No.	Artikelbeschreibung Description	Listenpreis List price	Netto-Stückpreis bei Net unit price for		
			€/Stück €/piece	1 Stück 1 piece	5 Stück 5 pieces	10 Stück 10 pieces
1	17P532	FinishPro HVLP ProContractor 9.5	1.985,-			Auf Anfrage On request
2	17P258	Ultra Max Cordless	779,-			Auf Anfrage On request

NEW. COMPACT. LIGHT.

1 AG250 LIGHT

- Extra leichte und kompakte Bauweise
- Besonders sanfter Abzug
- Especially light and compact design
- Very smooth and soft trigger



NEW. ROBUST. STRONG.

2 AG190-LB

- Extra robuste und stabile Bauweise
- Especially robust and strong design



AG SERIES

Pos.	Art.-Nr. Part-No.	Artikelbeschreibung Description	Listenpreis List price	Netto-Stückpreis bei Net unit price for		
			€/Stück €/piece	1 Stück 1 piece	5 Stück 5 pieces	10 Stück 10 pieces
1	AG250-LIGHT	1/4" - 7/8" - 250 Bar	89,-			
2	AG190-LB	3/8" - 7/8" - 250 Bar	198,-			



AG SERIES

Pos.	Art.-Nr. Part-No.	Artikelbeschreibung Description	Listenpreis	Netto-Stückpreis bei		
			List price	Net unit price for		
			€/Stück €/piece	1 Stück 1 piece	5 Stück 5 pieces	10 Stück 10 pieces

AG250 – 250 Bar – 3 mm – grün / green

1	AG250-G	1/4" - 11/16"	134,-			
	AG250-F	M16x1.5 - 11/16"				
	AG250-G-G	1/4" - 7/8"				

AG500 – 500 Bar – 3 mm – blau / blue

2	AG500-G-B	1/4" - 11/16"	148,-			
	AG500-F-B	M16x1.5 - 11/16"				
	AG500-G-G-B	1/4" - 7/8"				

AG500 – 500 Bar – 3 mm – rot / red

2	AG500-G	1/4" - 11/16"	148,-			
	AG500-F	M16x1.5 - 11/16"				
	AG500-G-G	1/4" - 7/8"				

AG500-L – 500 Bar – 5 mm – schwarz / black

3	AG500-L-G	1/4" - 11/16"	169,-			
	AG500-L-F	M16x1.5 - 11/16"				
	AG500-L-G-G	1/4" - 7/8"				

XXL – 500 Bar – 7 mm – schwarz / black

4	AG-XXL-G	1/2" - 7/8"	348,-			
	AG-XXL-F	1/2" - 11/16"				

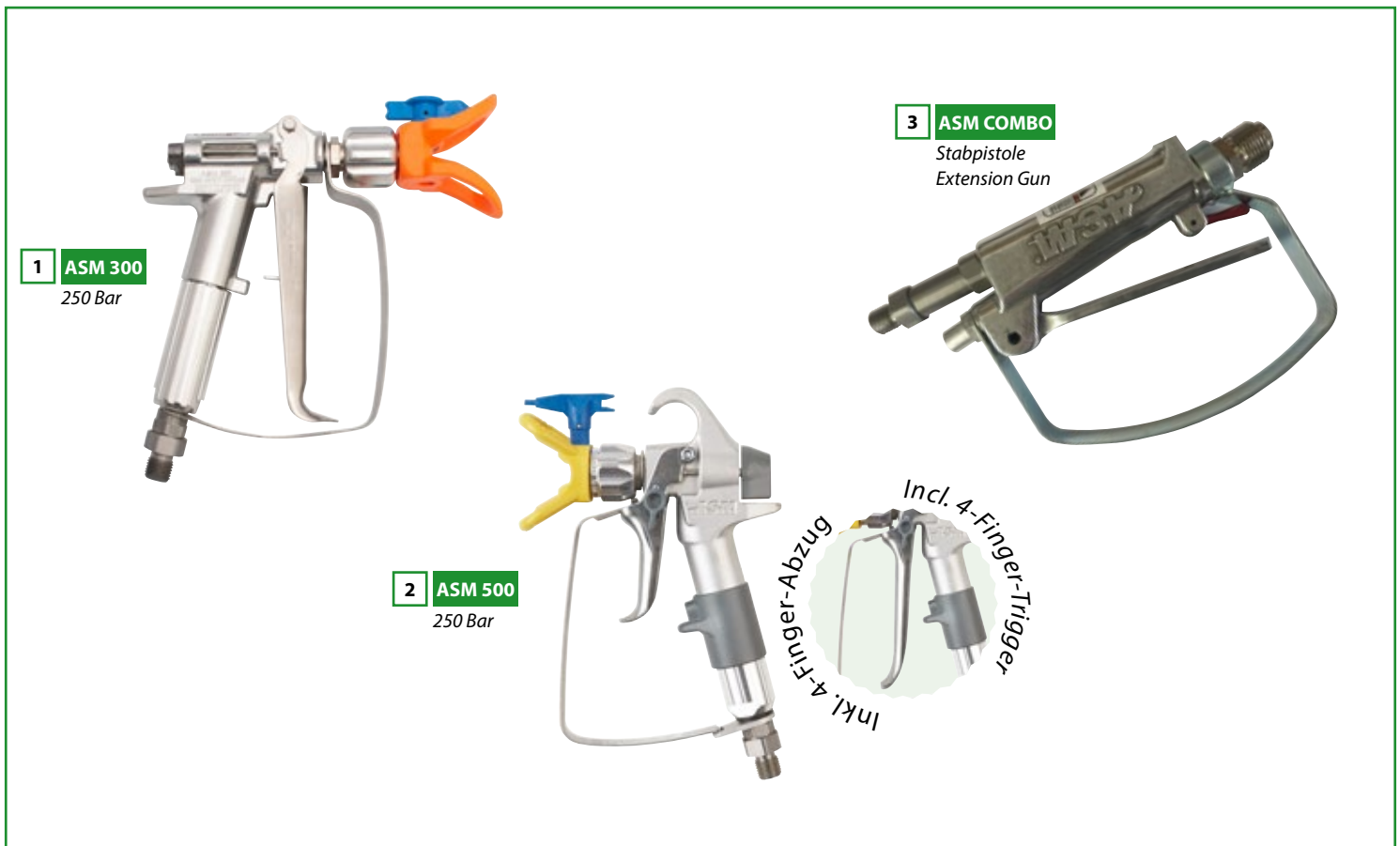

ASM

Pos.	Art.-Nr. Part-No.	Artikelbeschreibung Description	Listenpreis List price	Netto-Stückpreis bei Net unit price for		
			€/Stück €/piece	1 Stück 1 piece	5 Stück 5 pieces	10 Stück 10 pieces

ASM 300 inkl. Halter und Düse / With tip and base

1	351-SF	ASM300 - 250 Bar - 11/16" - 1/4" NPS + Super Zip	169,-			
	351-F	ASM300 - 250 Bar - 11/16" - 1/4" NPS + ZipTip				

ASM 500 inkl. Halter und Düse / With tip and base

2	500-G-UT	ASM500 - 250 Bar - 7/8" - 1/4" NPS + UNI Tip - 2/4 Finger	208,-			
---	----------	---	-------	--	--	--

ASM 6700 Combo-Gun

Ohne Düsenhalter und Düse / Without tip and base

3	670-G	1/4" - 7/8"	299,-			
	670-F	1/4" - 11/16"				



ASM SUPER ZIP
Seite / Page 58



ASM ZIP TIP
Seite / Page 59



ASM UNI TIP
Seite / Page 59

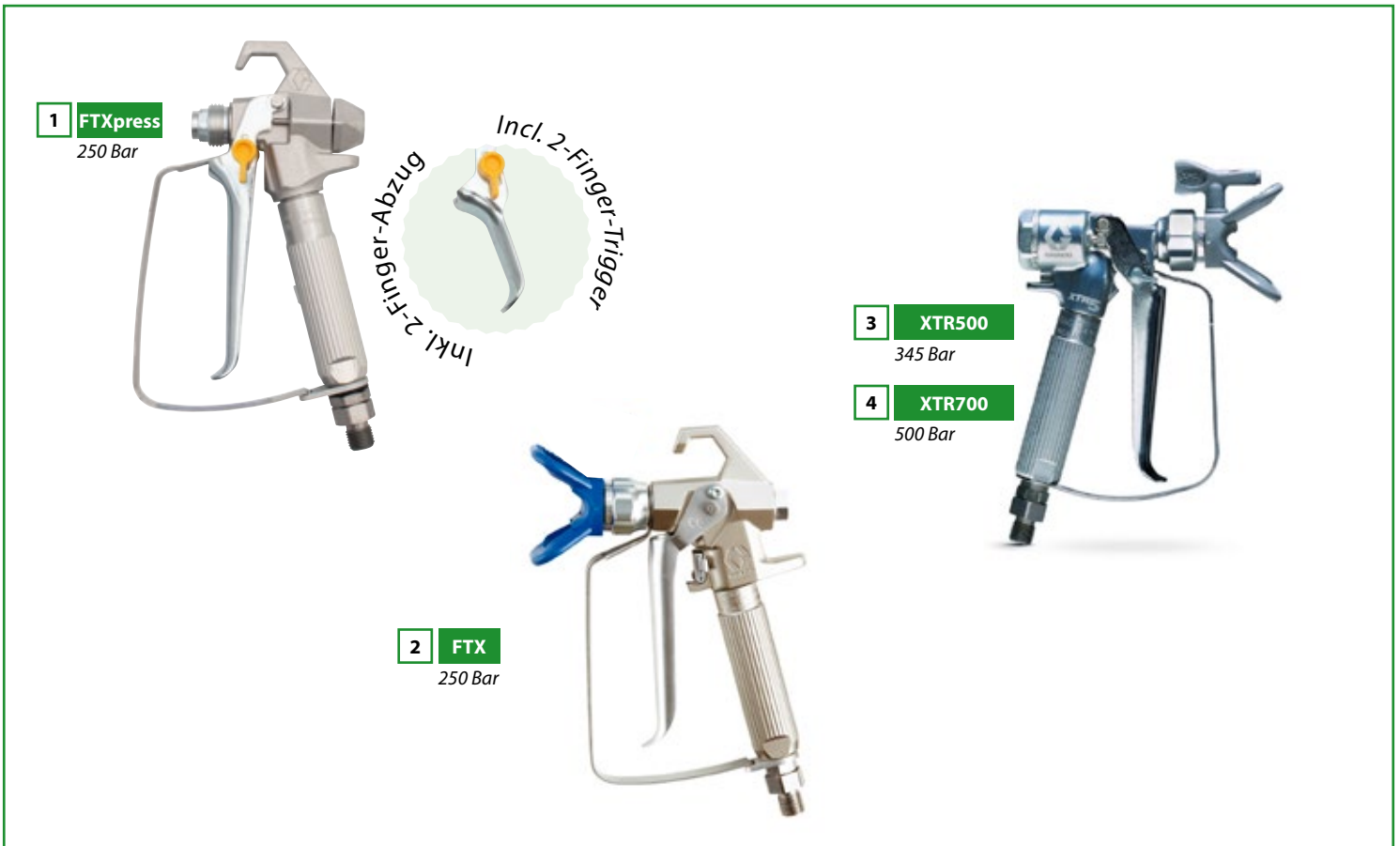

GRACO

Pos.	Art.-Nr. Part-No.	Artikelbeschreibung Description	Listenpreis	Netto-Stückpreis bei		
			List price	Net unit price for		
			€/Stück €/piece	1 Stück 1 piece	5 Stück 5 pieces	10 Stück 10 pieces

FTXpress

1	GR17N226-1	FTXpress - 250 Bar - 7/8" - 1/4" NPS - 2/4 Finger	269,-			
	GR17N226	FTXpress 250 Bar - 7/8" - 1/4" NPS - 2/4 Finger	Großverpackung 10 Stück 10 pieces bulk packed	2.490,-		

FTX inkl. Halter Rac X / With base Rac X

2	GR262116	GRACO FTX - 250 Bar - 7/8" - 1/4" NPS	239,-			
---	----------	---------------------------------------	-------	--	--	--

XTREME 500 & 700

3	XTR500	345 Bar - 4 Finger - ohne Düse / without Tip	362,-			
	XTR504	345 Bar - 4 Finger - mit XHD Düse / with XHD Tip	393,-			
4	XTR700	500 Bar - 4 Finger - ohne Düse / without Tip	400,-			
	XTR704	500 Bar - 4 Finger - mit XHD Düse / with XHD Tip	432,-			



1 TITAN

LX 80
Ohne Düsenhalter
Without Tip-Base

3 WAGNER

VECTOR

5 AIRLESS

Automatik
Automatic

2 WAGNER

AG14

4 WIWA

500 HD

Pos.	Art.-Nr. Part-No.	Artikelbeschreibung Description	Listenpreis List price	Netto-Stückpreis bei Net unit price for		
			€/Stück €/piece	1 Stück 1 piece	5 Stück 5 pieces	10 Stück 10 pieces

TITAN

1	AG-LX80	LX 80 - 250 Bar - 7/8" - 1/4" NPS ohne Düsenhalter und Düse / without Tip Base and Tip	269,-			
	AG-LX80-10	LX 80 - 250 Bar - 7/8" - 1/4" NPS ohne Düsenhalter und Düse / without Tip Base and Tip	2.490,-	Großverpackung 10 Stück 10 pieces bulk packed		

WAGNER

2	W502166	AG14 - 270 Bar - 11/16" - 1/4" NPS	337,00			
3	W538040	VECTOR Pro - 4-Finger - 250 Bar - 7/8" - 1/4" NPS	255,-			
	W538041	VECTOR Pro - 2-Finger - 250 Bar - 7/8" - 1/4" NPS	255,-			
	W538043	VECTOR Grip - 4-Finger - 250 Bar - 7/8" - 1/4" NPS	337,-			

WIWA

4	WIWA0015016	500 HD - 500 Bar - 11/16" - 1/4" NPS	368,-			
	WIWA0012092	500 HD Front - 500 Bar - 11/16" - 1/4" NPS				

AUTOMATIK / AUTOMATIC

5	AA250	Airless - 250 Bar - 11/16" - 1/4" NPS	558,-			
---	-------	---------------------------------------	-------	--	--	--

1 GOLDEN POINT

500 Bar
NEW

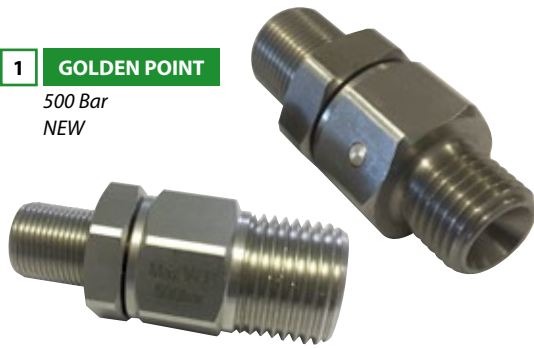

2 SERVICE SET

AG SERIES



Pos.	Art.-Nr. Part-No.	Artikelbeschreibung Description	Listenpreis	Netto-Stückpreis bei		
			€/Stück €/piece	1 Stück 1 piece	10 Stück 10 pieces	25 Stück 25 pieces

Pistolendrehgelenke - Kugelgelagert - Edelstahl - 500 Bar
Gun Swivels - Ball Bearing - Stainless Steel - 500 Bar

1	G-7004-SS	M14x1.0 (M) x 1/4" NPS (M) - Edelstahl / stainless steel	49,-			
	G-7005-SS	M14x1.0 (M) x M16x1.5 (M) - Edelstahl / stainless steel				
	G-7006-SS	M14x1.0 (M) x 3/8" NPS (M) - Edelstahl / stainless steel				
	G-7007-SS	M14x1.0 (M) x 1/2" JIC (M) - Edelstahl / stainless steel				

Service Sets AG SERIES

			€/Stück €/piece	1 Stück 1 piece	5 Stück 5 pieces	10 Stück 10 pieces
2	AG250-L-SERVICE	Passend AG250-LIGHT / Fitting AG250-LIGHT	36,-			
	AG-190#4	Passend AG190 / Fitting AG190	39,-			
	79507	Passend AG250 / Fitting AG250 - Compact	49,-			
	79508	Passend AG500 / Fitting AG500 - Compact				
	79509	Passend AG500-L / Fitting AG500-L - Compact				
	76850	Passend XXL / Fitting XXL - Compact				

Weitere **Service Sets** für **WAGNER, GRACO, WIWA, etc.** auf Anfrage
Further **service sets** for **WAGNER, GRACO, WIWA, etc.** on request

NEW. ALUMINIUM.

1 ALU

15/30/50/75/100 cm
11/16"
7/8"



2 NEW

11/16"
7/8"



3 LINE-SPRAY

7/8"



Düsenverlängerungen / Pole-Extensions

Pos.	Art.-Nr. Part-No.	Artikelbeschreibung Description	Listenpreis List price	Netto-Stückpreis bei Net unit price for		
			€/Stück €/piece	1 Stück 1 piece	5 Stück 5 pieces	10 Stück 10 pieces
1	63-150-F	15 cm - 11/16" - incl. Adapter	19,-			
	63-150-G	15 cm - 7/8" - incl. Adapter				
	63-300-F	30 cm - 11/16" - incl. Adapter	19,-			
	63-300-G	30 cm - 7/8" - incl. Adapter				
	63-500-F	50 cm - 11/16" - incl. Adapter	22,-			
	63-500-G	50 cm - 7/8" - incl. Adapter				
	63-750-F	75 cm - 11/16" - incl. Adapter	24,-			
	63-750-G	75 cm - 7/8" - incl. Adapter				
	63-1000-F	100 cm - 11/16" - incl. Adapter	28,-			
	63-1000-G	100 cm - 7/8" - incl. Adapter				
2	63-AH-F	Kniegelenk / Anglehead - 11/16"	18,-			
	63-AH-G	Kniegelenk / Anglehead - 7/8"				
3	LINE-SPRAY	7/8"	59,-			



Düsenverlängerungen / Pole-Extensions

Pos.	Art.-Nr. Part-No.	Artikelbeschreibung Description	Listenpreis	Netto-Stückpreis bei		
			List price	Net unit price for		
			€/Stück €/piece	1 Stück 1 piece	5 Stück 5 pieces	10 Stück 10 pieces
1	32-150-F	15 cm - 11/16" - incl. Adapter	49,-			
	32-150-G	15 cm - 7/8" - incl. Adapter				
	32-300-F	30 cm - 11/16" - incl. Adapter	52,-			
	32-300-G	30 cm - 7/8" - incl. Adapter				
	32-450-F	45 cm - 11/16" - incl. Adapter	54,-			
	32-450-G	45 cm - 7/8" - incl. Adapter				
	32-600-F	60 cm - 11/16" - incl. Adapter	58,-			
	32-600-G	60 cm - 7/8" - incl. Adapter				
2	32-1000	Verlängerung / Maxi Pole Only - 1 m	79,-			
	32-1000-F	Mit Kniegelenk / With anglehead - 1 m - 11/16"	138,-			
	32-1000-G	Mit Kniegelenk / With anglehead - 1 m - 7/8"				
3	32-7506-F	Kniegelenk / Anglehead - 11/16"	39,-			
	32-7506-G	Kniegelenk / Anglehead - 7/8"				
4	32-7551-F	Adapter für Pistole / Adapter for gun - 11/16"	29,-			
	32-7551-G	Adapter für Pistole / Adapter for gun - 7/8"				
5	32-3430-F	Adapter für Düsenhalter / Adapter for tip base - 11/16"	19,-			
	32-3430-G	Adapter für Düsenhalter / Adapter for tip base - 7/8"				

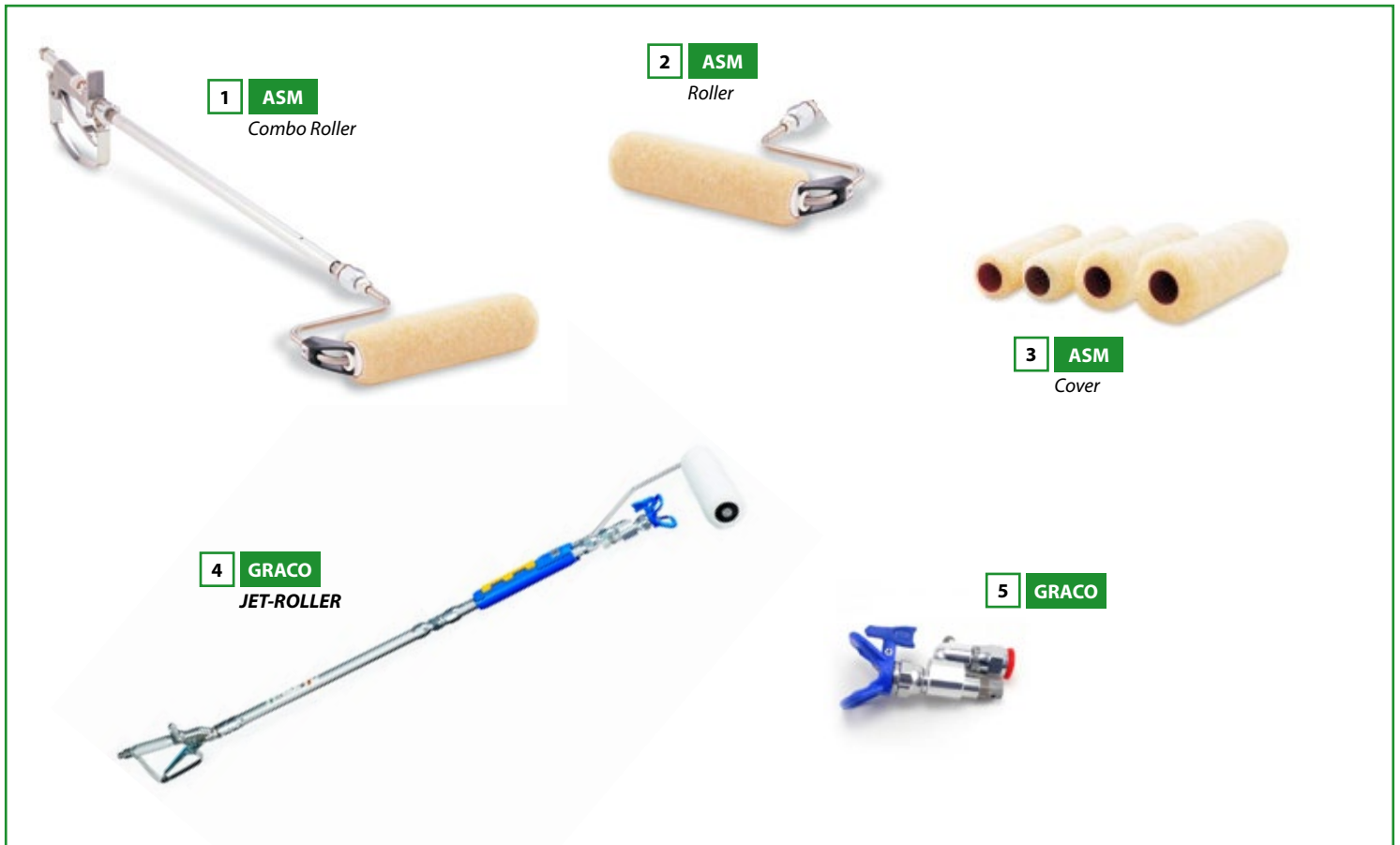

Pos.	Art.-Nr. Part-No.	Artikelbeschreibung Description	Listenpreis List price	Netto-Stückpreis bei Net unit price for		
			€/Stück €/piece	1 Stück 1 piece	5 Stück 5 pieces	10 Stück 10 pieces

ASM Roller

1	670-ROLL-F	ASM Stabpistole inkl. Verlängerung 1m & Rollervorsatz - 11/16" ASM Combo Gun incl. extension 1m & roller unit cpl. - 11/16"	589,-			
	670-ROLL-G	ASM Stabpistole inkl. Verlängerung 1m & Rollervorsatz - 7/8" ASM Combo Gun incl. extension 1m & roller unit cpl. - 7/8"				
2	770900F	Rollervorsatz kpl. / Roller unit cpl. - 9" (GR244271)	119,-			
3	7722	Walze fein / Cover smooth - 13 mm (GR186944)	19,-			
	7723	Walze mittel / Cover medium - 19 mm (GR186945)				

GRACO JET-ROLLER

4	24V490	18 cm + Clean-Shot + RAC-X 515 (Pistole + Verlängerung + Clean-Shot + Düse) 18 cm + Clean-Shot + RAC-X 515 (Gun + Extension + Clean-Shot + Tip)	583,-			
	24V491	25 cm + Clean-Shot + RAC-X 721 (Pistole + Verlängerung + Clean-Shot + Düse) 25 cm + Clean-Shot + RAC-X 721 (Gun + Extension + Clean-Shot + Tip)				
5	287030	Cleanshot 7/8"	199,-			



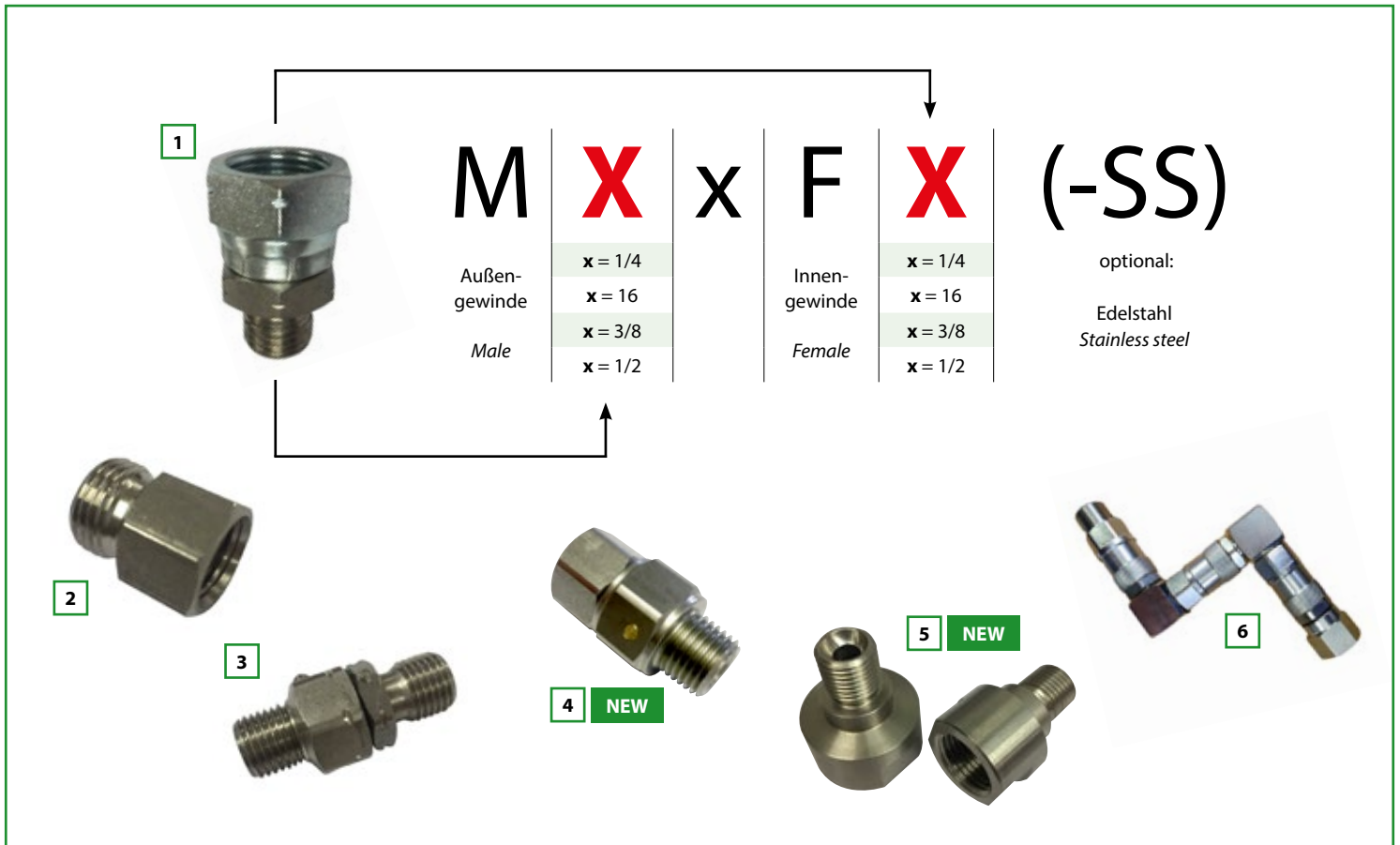

Pos.	Art.-Nr. Part-No.	Artikelbeschreibung Description	Listenpreis List price	Netto-Stückpreis bei Net unit price for		
			€/Stück €/piece	1 Stück 1 piece	10 Stück 10 pieces	25 Stück 25 pieces

Adapter - Hochdruck / High Pressure - 500 Bar

1	MxN x FxN	x = 1/4" / M16x1.5 / 3/8"	5,40			
	MxN x FxN-SS	x = 1/4" / M16x1.5 / 3/8" - Edelstahl / stainless steel	10,-			
	MxN x FxN	x = 3/8" / 1/2"	10,-			
	MxN x FxN-SS	x = 3/8" / 1/2" - Edelstahl / stainless steel	19,80			
2	W34041-LB	Adapter 1/4" IG (F) - M16x1.5 (M) - Edelstahl / stainless steel	9,80			

**Hochdruckdrehgelenke - Kugelgelagert - Edelstahl - 500 Bar
High Pressure Swivels - Ball Bearing - Stainless Steel - 500 Bar**

3	G-7008-SS	1/4" NPS (M) x 1/4" NPS (M) - Edelstahl / stainless steel	49,-			
	G-7009-SS	1/4" NPS (F) x 1/4" NPS (M) - Edelstahl / stainless steel				
4	G-7011-SS	M16x1.5 (F) x 1/4" NPS (M) - Edelstahl / stainless steel				
	G-7012-SS	1/4" NPS (F) x 3/8" NPS (M) - Edelstahl / stainless steel				
	G-7024-SS	3/8" NPS (F) x 3/8" NPS (M) - Edelstahl / stainless steel				

Adapter Diffusor

5	32-1/4-11/16	11/16" (F) x 1/4" NPS (M) - Edelstahl / stainless steel	15,90			
	32-1/4-7/8	7/8" (F) x 1/4" NPS (M) - Edelstahl / stainless steel				

Z-Drehgelenk / Z-Swivel - 350 Bar

6	HP-Z-1/4-350	Kupplung verzinkt, 3-fach drehbar - 1/4" (M) x 1/4" (F) Coupling Zinc-plated, triple swivel, 1/4" (M) x 1/4" (F)	56,-			
	HP-Z-3/8-350	Kupplung verzinkt, 3-fach drehbar - 3/8" (M) x 3/8" (F) Coupling Zinc-plated, triple swivel, 3/8" (M) x 3/8" (F)	69,-			
	HP-Z-1/2-350	Kupplung verzinkt, 3-fach drehbar - 1/2" (M) x 1/2" (F) Coupling Zinc-plated, triple swivel, 1/2" (M) x 1/2" (F)	99,-			



Pos.	Art.-Nr. Part-No.	Artikelbeschreibung Description	Listenpreis List price	Netto-Stückpreis bei Net unit price for		
			€/Stück €/piece	1 Stück 1 piece	5 Stück 5 pieces	10 Stück 10 pieces
Injektion / Injection						
1	INJECT11/16	Verpressschlauch inkl. Mundstück ohne Manometer - 11/16" <i>Injection hose incl. jaw grip nozzle without gauge - 11/16"</i>	34,-			
	INJECT7/8	Verpressschlauch inkl. Mundstück ohne Manometer - 7/8" <i>Injection hose incl. jaw grip nozzle without gauge - 7/8"</i>				
2	INJECT11/16 MANO	Verpressschlauch inkl. Mundstück und Manometer - 11/16" <i>Injection hose incl. jaw grip nozzle and gauge - 11/16"</i>	98,-			
	INJECT7/8 MANO	Verpressschlauch inkl. Mundstück und Manometer - 7/8" <i>Injection hose incl. jaw grip nozzle and gauge - 7/8"</i>				
	LA07725840	Flex. Verpressschlauch / Flex. inject hose - 25 cm	9,90			
3	LA01840	4-Backen Mundstück / 4-jaw grip nozzle	4,90			
4	MM50A	Manometer - lösemittelbeständiges Sicherheitsglas - Ø 50 axial <i>Gauge - solvent resistant safety glass - Ø 50 axial</i>	40,-			
5	MANO-DI	Profildichtung für Manometer / Profile Seal for Gauge	0,90			
6	AG250-LIGHT	1/4" - 7/8" - 250 Bar	89,-			

UNIVERSAL M100 SERIE

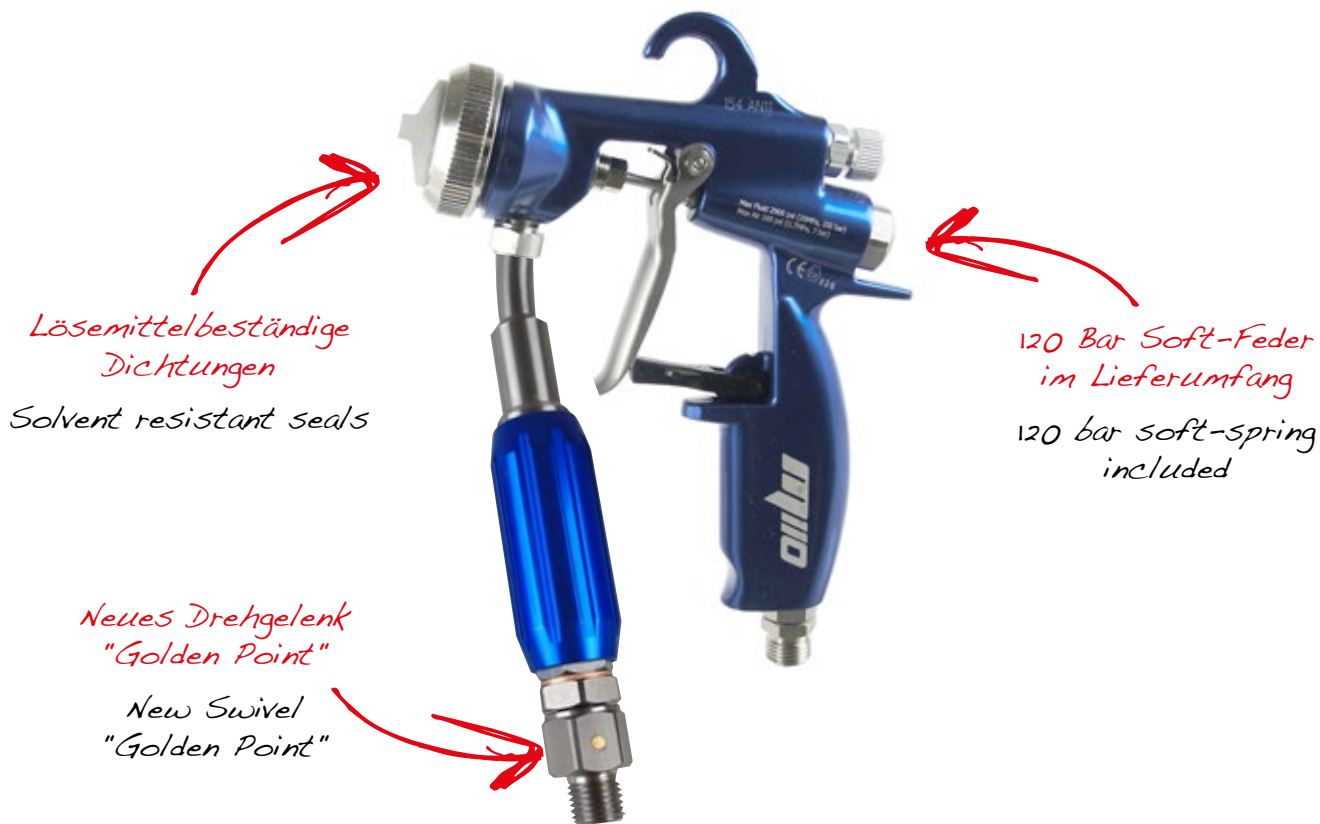



1. Pistolentyp Gun Type

- 110** passend Optima
fitting Optima
- 120** passend Kremlin/Graco
fitting Kremlin/Graco
- 140** passend Wagner
fitting Wagner





2. Justierung Adjustment

- S**  Standard
Standard

3. Filtertyp Filter Type

- L**  Lang
Long
- S**  SPALT
SPALT
- O**  Einschraub
Screw-In

4. Düsensystem Tip System

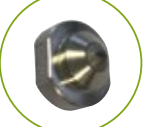
- R**  passend Optima rund
fitting Optima round
- H**  passend Optima sechskant
fitting Optima hexagon
- K**  passend Kremlin
fitting Kremlin
- G**  passend Graco
fitting Graco
- W**  passend Wagner
fitting Wagner





1. 2. 3. 4.

Pistolentyp
Gun Type Version Filter Düsentyp
Tip System

M XXX -X -X -X

110 / 120 / 140 S L / S / O R / H / K / G / W

M100

Pos.	Art.-Nr. Part-No.	Artikelbeschreibung Description	Listenpreis List price	Netto-Stückpreis bei Net unit price for		
			€/Stück €/piece	1 Stück 1 piece	3 Stück 3 pieces	5 Stück 5 pieces

Kombinationsbeispiele / Combination Examples

M110-S-O-R	Pistole passend Optima "rund" - Einschraubfilter - 428 Gun fitting Optima "round" - Screw-In Filter - 428	398,-			
M110-S-L-R	Pistole passend Optima "rund" - langer Filter - 428 Gun fitting Optima "round" - Filter long - 428	458,-			
M110-S-O-H	Pistole passend Optima "sechskant" - Einschraubfilter - 428 Gun fitting Optima "hexagon" - Screw-In Filter - 428	418,-			
M110-S-L-H	Pistole passend Optima "sechskant" - langer Filter - 428 Gun fitting Optima "hexagon" - Filter long - 428	468,-			
M120-S-S-K	Pistole passend Kremlin - SPALT Filter - 06.094 Gun fitting Kremlin - SPALT Filter - 06.094	418,-			
M120-S-L-K	Pistole passend Kremlin - langer Filter - 06.094 Gun fitting Kremlin - Filter long - 06.094	468,-			
M120-S-S-G	Pistole passend Graco - SPALT Filter - 411 Gun fitting Graco - SPALT Filter - 411	418,-			
M120-S-L-G	Pistole passend Graco - langer Filter - 411 Gun fitting Graco - Filter long - 411	468,-			
M140-S-L-W-R	Pistole passend Wagner - langer Filter - 411 - rote Luftkappe Gun fitting Wagner - Filter long - 411 - red AirCap	468,-			
M140-S-L-W-B	Pistole passend Wagner - langer Filter - 411 - blaue Luftkappe Gun fitting Wagner - Filter long - 411 - blue AirCap				



Pos.	Art.-Nr. Part-No.	Artikelbeschreibung Description	Listenpreis List price	Netto-Stückpreis bei Net unit price for		
			€/Stück €/piece	1 Stück 1 piece	3 Stück 3 pieces	5 Stück 5 pieces
WAGNER						
1	W2302513	GM4100AC - mit Luftkappe rot / With AirCap red	628,-			
	W2302514	GM4100AC - mit Luftkappe blau / With AirCap blue				
2	W2365346	GM4500 - Ohne Luftkappe / Without AirCap	367,-			
	W2368271	GM4500 - Mit Luftkappe rot / With AirCap red	506,-			
	W2368269	GM4500 - Mit Luftkappe blau / With AirCap blue				
3	W394156	GM4600 - Mit Luftkappe blau / With AirCap blue	680,-			
	W394157	GM4600 - Mit Luftkappe rot / With AirCap red				
4	W2313585	GM4700 - Ohne Luftkappe / Without AirCap	537,-			
	W2313586	GM4700 - Mit Luftkappe rot / With AirCap red	673,-			
	W2313587	GM4700 - Mit Luftkappe blau / With AirCap blue				
GRACO						
5	GR24C853	G15 - inkl. Düse AAM G15 - incl. Tip AAM	823,-			
6	GR24C855	G40 - inkl. Düse AAM G40 - incl. Tip AAM	913,-			
	GR24C857	G40 - inkl. Wendedüse LTX G40 - incl. reversible Tip LTX				

1 WAGNER
GM5000 EAC



2 WAGNER
ACR5000



3 WAGNER
7,5/10/15 m



5 WAGNER
ACF5000
395-XXX



7 LowBudget



6 WAGNER
R11-R22
132-7XX



4 WAGNER
VM500/VM5000



WAGNER Elektrostatik / Electrostatic

Pos.	Art.-Nr. Part-No.	Artikelbeschreibung Description	Listenpreis List price	Netto-Stückpreis bei Net unit price for		
			€/Stück €/piece	1 Stück 1 piece	3 Stück 3 pieces	5 Stück 5 pieces
	W2328709	SprayPack GM 5000 EAC - VM5000 - ACF5000 - 7,5 m	6.265,-			Auf Anfrage On request
1	W2309871	Elektrostatik AC-Handpistole / Electrostatic AC-Gun - GM5000 EAC	3.999,-			Auf Anfrage On request
	W2309882	Luftkappe rot / AirCap red	157,-			
	W2314203	Luftkappe blau / AirCap blue				
2	W2309883	Rundstrahldüsenaufsatz / Round Jet Nozzle Holder - ACR5000	395,-			Auf Anfrage On request
3	W2339171	Schlauchpaket / Hose Package - 7,5 m	335,-			Auf Anfrage On request
	W2339172	Schlauchpaket / Hose Package - 10 m	486,-			
	W2339173	Schlauchpaket / Hose Package - 15 m	602,-			
4	W2310478	Steuergerät / Control Unit - VM500	1.771,-			
	W2310477	Steuergerät / Control Unit - VM5000	2.227,-			
			€/Stück €/piece	1 Stück 1 piece	10 Stück 10 pieces	25 Stück 25 pieces
5	W395-XXX	Düse / Tip - ACF5000	104,-			
6	W132-7XX	Rundstrahldüse / Round Jet Nozzle - R11-R22	127,-			
			€/Stück €/piece	1 Stück 1 piece	50 Stück 50 pieces	100 Stück 100 pieces
7	ESTA-WA-LB	Handschuh / Glove	20,-			
	ESTA-100	Handschuh / Glove - TYVEK	6,40			

MADE IN GERMANY. AIRLESS. AIRCOMBI.

Produktion nach Maß!

- Standard- / GTD- / Tonnen-Düsen
- Durchflussmenge, Spritzwinkel und Düsengröße (Bohrung)
- Strahlform: Flach-, Voll-, Rundstrahl
- Edelstahl Gehäuse / Düsenträger
- Einsatzgebiete: Farbe, Wasser, Lebensmittel, uvm.
- Vorzerstäuber
- Sonderformen
- Gravur / Verpackung / Label

Customised Production!

- Standard- / GTD- / Barrel-Tips
- Flow Rate, Spray Angle and Tip Size
- Spray Form: Flat, Solid Stream, Round
- Stainless Steel Tip Housings
- Application: Paint, Water, Food and many more.
- Preorifice
- Special Types
- Engraving / Packing / Labelling



Gravur
Engraving

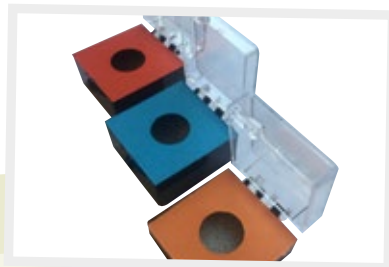

Label
Labelling

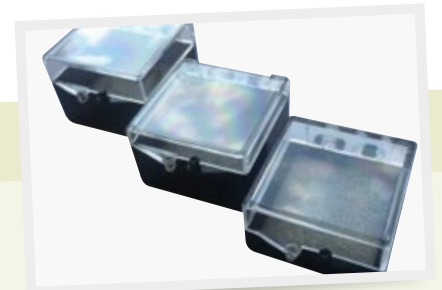

Verpackung
Packing

INSERT. PRODUCER. GEMINI.



FARBE • WASSER • INDUSTRIE



Wolframkarbid
Hartmetall
0-500 Bar

Tungsten Carbide
Hard Metal
0-500 Bar



Düsenkern
Tip-Insert



Vorzerstäuber
Preorifice



Düsenträger
Tip-Housing



Airless

Pos.	Art.-Nr. Part-No.	Artikelbeschreibung Description	Listenpreis	Netto-Stückpreis bei		
			List price	Net unit price for		
			€/Stück €/piece	1 Stück 1 piece	10 Stück 10 pieces	25 Stück 25 pieces

STANDARD

1	93-XXX	Flachstrahldüse / Flat-Tip	20,-			
	93-XXX-FF	Flachstrahldüse mit Vorzerstäuber / Flat-Tip with preorifice	24,-			
	93-XXX-SS	Edelstahlvariante / Stainless steel version	24,-			
	93-XXX-FF-SS	Edelstahlvariante mit Vorzerstäuber / Stainless steel version with preorifice	28,-			

1a	43052-LB	Dichtung / Seal	1,05			
----	----------	-----------------	------	--	--	--

2	163-XXX-FF-SS	Flachstrahldüse lang mit Vorzerstäuber - Edelstahl Flat-Tip long with preorifice - stainless steel	36,-			
	GR163-XXX	Graco Original Flachstrahldüse mit Vorzerstäuber / Flat-Tip with preorifice	83,-			

2a	43052-LB	Dichtung / Seal	1,05			
----	----------	-----------------	------	--	--	--

3	420-XX	Düsenhalter inkl. Schutz / Base incl. safety guard - 11/16" & 7/8"	12,90			
---	--------	--	-------	--	--	--

4	NUT-XX	Überwurfmutter / Wrap nut - 11/16", 7/8" & M18x1	4,90			
	NUT-11/16-SS	Überwurfmutter Edelstahl / Wrap nut stainless steel - 11/16"	5,80			

GEMINI No.201 - 600 Bar

5	D-160-XXX	Einbaudüse für / Tip insert for - D-201	16,-			
6	D-300-XXX	Einbaudüse kpl. montiert mit Kugel / Tip insert cpl. assembled with ball	34,-			
7	D-201-F	Wendeschalter kpl. / Reversible Tip cpl. - 11/16"	64,-			
	D-201-G	Wendeschalter kpl. / Reversible Tip cpl. - 7/8"				



1 DÜSE / TIP

Rundstrahl inkl. Vorzerstäuber
Round Jet incl. preorifice



4 MINI

Rohrinnenbeschichtungspistole
Inner Tube Coating Gun



2 LANCE

Hohlraumlanze kpl.
Cavity Lance cpl.



3 E-STATIC

Rundstrahldüse inkl. Aufnahme
Round Jet Tip incl. support



5 BIG

Rohrinnenbeschichtungspistole
Inner Tube Coating Gun



www.bit.ly/2lUnmlb

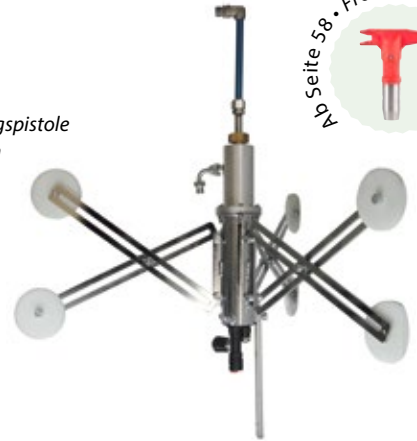

Pos.	Art.-Nr. Part-No.	Artikelbeschreibung Description	Listenpreis	Netto-Stückpreis bei		
			List price	Net unit price for		
			€/Stück €/piece	1 Stück 1 piece	5 Stück 5 pieces	10 Stück 10 pieces

Rundstrahldüse / Round Jet Tip

1	RST-11	Rundstrahldüse inkl. Vorzerstäuber / Round Jet Tip incl. preorifice R11 - 0.16 Ltr./min. (100 Bar)	90,-			
	RST-15	Rundstrahldüse inkl. Vorzerstäuber / Round Jet Tip incl. preorifice R15 - 0.38 Ltr./min. (100 Bar)				
	RST-16	Rundstrahldüse inkl. Vorzerstäuber / Round Jet Tip incl. preorifice R16 - 0.43 Ltr./min. (100 Bar)				

Hohlraumlanze / Cavity Lance

2	RST-L-120-RXX-F	Lanze 120 mm inkl. Düse 11/15/16 nach Wahl und Überwurfmutter 11/16" Lance 120 mm incl. Tip 11/15/16 of your choice and wrap nut 11/16"	169,-			
	RST-L-120-RXX-G	Lanze 120 mm inkl. Düse 11/15/16 nach Wahl und Überwurfmutter 7/8" Lance 120 mm incl. Tip 11/15/16 of your choice and wrap nut 7/8"				

Rundstrahldüse Elektrostatik / Round Jet Tip Electrostatic

3	RST-E-RXX	Rundstrahldüse für Elektrostatik inkl. Aufnahme - 11/15/16 Round Jet Tip for Electrostatic incl. support - 11/15/16	90,-			
---	-----------	--	------	--	--	--

Weitere **Düsenverlängerungen (starr und flexibel)** auf Anfrage

Further **Tip Extensions (fix and flexible)** on request

Rohrinnenbeschichtung / Inner Tube Coating

4	PNEU-MINI	Pistole / Gun "MINI" - 30-250 mm	199,-			
5	PNEU-BIG	Pistole / Gun "BIG" - 250-750 mm	2.900,-			

SUPER ZIP. ASM.



1 ASM
SUPER ZIP
350 Bar



2 ASM
11/16"
7/8"
M18x1.0
M18x1.5

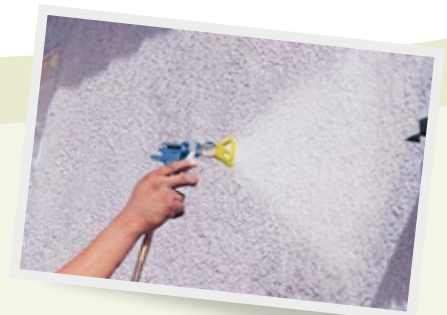
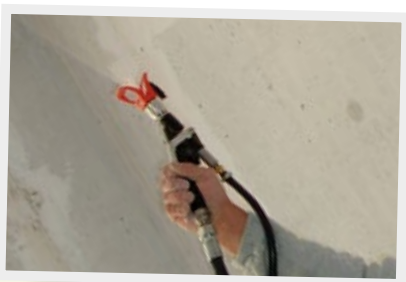

ASM SUPER ZIP

Pos.	Art.-Nr. Part-No.	Artikelbeschreibung Description	Listenpreis	Netto-Stückpreis bei		
			List price	Net unit price for		
			€/Stück €/piece	1 Stück 1 piece	10 Stück 10 pieces	30 Stück 30 pieces
1	59-XXX	Wendedüse / Reversible tip - 350 Bar	39,-			
	5901-F	Düsenhalter / Tip base - 11/16"	39,-			
	5901HP-F-LB	Düsenhalter / Tip base - 500 Bar - 11/16"	39,-			
2	5901-G	Düsenhalter / Tip base - 7/8"	39,-			
	5901-M1.0	Düsenhalter / Tip base - M18x1.0	44,-			
	5901-M1.5	Düsenhalter / Tip base - M18x1.5	44,-			
	5907	Dichtungssatz / Seal-kit	14,-			

ZIP TIP. ASM.



1 ASM
ZIP TIP
350 Bar

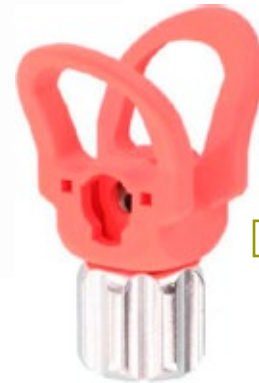

2 ASM
11/16"
7/8"
M18x1.0
M18x1.5

UNITIP. ASM.



3 ASM
UNI TIP
350 Bar



4 ASM
11/16"
7/8"
M18x1.0
M18x1.5

ASM ZIP TIP

Pos.	Art.-Nr. Part-No.	Artikelbeschreibung Description	Listenpreis	Netto-Stückpreis bei		
			List price	Net unit price for		
			€/Stück €/piece	1 Stück 1 piece	10 Stück 10 pieces	30 Stück 30 pieces
1	55-XXX	Wendedüse / Reversible tip - 350 Bar	39,-			
2	5701-F	Düsenhalter / Tip base - 11/16"	39,-			
	5701-G	Düsenhalter / Tip base - 7/8"	39,-			
	5707	Dichtungssatz / Seal-kit	16,-			

ASM UNI TIP

3	69-XXX	Wendedüse / Reversible tip - 350 Bar	39,-			
	69FF-XXX	Wendedüse mit Vorzerstäuber / Reversible tip with preorifice - 350 Bar	59,-			
	69-XXXST	Wendedüse für Strichmarkierungen / Reversible tip STRIPING - 350 Bar	39,-			
4	6901-F	Düsenhalter / Tip base - 11/16"	39,-			
	6901-G	Düsenhalter / Tip base - 7/8"	39,-			
	6901-M1.0	Düsenhalter / Tip base - M18x1.0	44,-			
	6901-M1.5	Düsenhalter / Tip base - M18x1.5	44,-			
	6907	Dichtungssatz (5 Stück) / Seal-kit (5 pieces)	26,-			

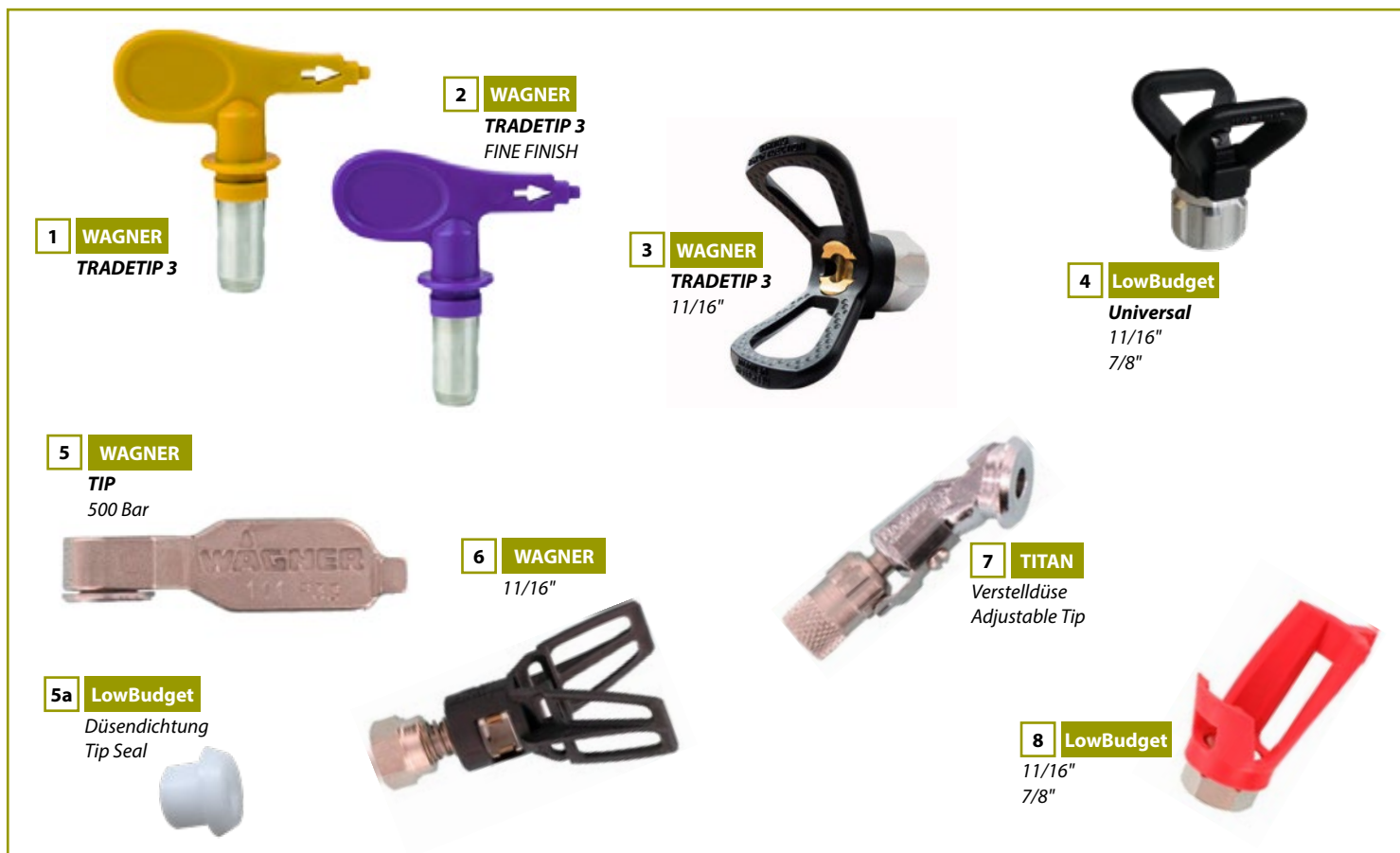

Airless Wendedüsen / Reversible Tips

Pos.	Art.-Nr. Part-No.	Artikelbeschreibung Description	Listenpreis List price	Netto-Stückpreis bei Net unit price for		
			€/Stück €/piece	1 Stück 1 piece	10 Stück 10 pieces	25 Stück 25 pieces
WAGNER						
1	W553-XXX	Trade Tip 3	46,20			
2	W554-XXX	Trade Tip 3 Fine Finish	51,40			
3	W289391	Original Düsenhalter / Tip base - 11/16"	46,20			
4	UNIVERSAL-11/16LB	LowBudget Düsenhalter / Tip base - 11/16"	19,-			
	UNIVERSAL-7/8-LB	LowBudget Düsenhalter / Tip base - 7/8"				

WAGNER TIP

5	W1088-XXX	Wendedüse / Reversible Tip - 500 Bar	91,-			
5a	W-TIP-SEAL-LB	Düsendichtung / Tip Seal	3,86			
6	W1088001	Original Düsenhalter / Tip base - 11/16"	66,70			

Verstelldüse / Adjustable Tip

7	TV015	0,13 - 0,46 mm	89,-			
	TV020	0,18 - 0,48 mm				
	TV024	0,24 - 0,58 mm				
	TV028	0,28 - 0,66 mm				
	TV041	0,43 - 0,88 mm				
	TV049	0,53 - 1,37 mm				
8	TV100-LB	LowBudget Düsenhalter rot / Tip base red - 11/16"	13,90			
	TV200-LB	LowBudget Düsenhalter rot / Tip base red - 7/8"				



Airless Wendedüsen / Reversible Tips

Pos.	Art.-Nr. Part-No.	Artikelbeschreibung Description	Listenpreis List price	Netto-Stückpreis bei Net unit price for		
			€/Stück €/piece	1 Stück 1 piece	10 Stück 10 pieces	25 Stück 25 pieces
GRACO RAC V						
1	GR262-XXX	Wendedüse / Reversible Tip - 350 Bar	87,-			
2	GR243161	Original Düsenhalter / Tip base - 7/8"	57,-			
	GR243263	Original Düsenhalter / Tip base - 11/16"				
3	UNIVERSAL-11/16-LB	LowBudget Düsenhalter / Tip base - 11/16"	19,-			
	UNIVERSAL-7/8-LB	LowBudget Düsenhalter / Tip base - 7/8"				
GRACO RAC X						
4	LTX-XXX	Wendedüse blau - 350 Bar - Größe .007-.013 Reversible Tip blue - 350 Bar - Size .007-.013	65,-			
	PAA-XXX	Wendedüse blau - 350 Bar - Größe .015-.025 Reversible Tip blue - 350 Bar - Size .015-.025				
	HDA-XXX	Wendedüse braun - 350 Bar - Größe .027-.071 Reversible Tip brown - 350 Bar - Size .027-.071	65,-			
	FFLP-XXX	Wendedüse grün mit Vorzerstäuber - 350 Bar Reversible Tip green with preorifice - 350 Bar	72,-			
5	GR246437	Original Düsenhalter / Tip base - 11/16"	43,-			
	GR246215	Original Düsenhalter / Tip base - 7/8"				
6	BASE-X-11/16-LB	LowBudget Düsenhalter / Tip base - 11/16"	19,-			
	BASE-X-7/8-LB	LowBudget Düsenhalter / Tip base - 7/8"				

GRACO. 500 BAR. XHD.



1 GRACO
XHD
500 Bar

2 GRACO
11/16"
7/8"

Pos.	Art.-Nr. Part-No.	Artikelbeschreibung Description	Listenpreis List price	Netto-Stückpreis bei Net unit price for		
			€/Stück €/piece	1 Stück 1 piece	10 Stück 10 pieces	25 Stück 25 pieces
1	XHD-XXX	Wendedüse / Reversible Tip	74,-			
2	XHD001	Düsenhalter / Tip base - 7/8"	39,-			
	XHD005	Düsenhalter / Tip base - 11/16"				



AirCombi

Pos.	Art.-Nr. Part-No.	Artikelbeschreibung Description	Listenpreis List price	Netto-Stückpreis bei Net unit price for		
			€/Stück €/piece	1 Stück 1 piece	10 Stück 10 pieces	25 Stück 25 pieces

GRACO

1	GR-AAM-XXX	Original Düse / Tip - AAM	105,-			
	GR-AAF-XXX	Original Düse / Tip - AAF	107,-			
2	GR-GG4-XXX	Original Düse / Tip - GG4	115,-			

WAGNER

3	W148-XXX	Original Düse / Tip - 2000 Serie	111,-			
4	W379-XXX	Original Düse / Tip - 3000/4000 Serie	101,-			
	W321-XXX	Original Düse mit Vorzerstäuber / Tip with preorifice - 3000/4000 Serie	114,-			
5	W2313494	Original Luftkappe rot / Aircap red - 4700	134,-			
	W2313497	Original Luftkappe blau / Aircap blue - 4700				
6	W395-XXX	Original Elektrostatikdüse / Electrostatic Tip - ACF 5000	104,-			
7	W132-7XX	Original Rundstrahldüse / Round Jet Nozzle - R11-R22	127,-			



1 LowBudget
TYP "O-R"



2 LowBudget
TYP "O-H"



3 LowBudget
TYP "GR"



4 LowBudget
TYP "KR"



AirCombi

Pos.	Art.-Nr. Part-No.	Artikelbeschreibung Description	Listenpreis	Netto-Stückpreis bei		
			List price	Net unit price for		
			€/Stück €/piece	1 Stück 1 piece	10 Stück 10 pieces	25 Stück 25 pieces

TYP "O"

1	AC-O-XXX-LB	Düse runde Ausführung / Tip round version	30,-			
	AC-O-R-LB	Luftkappe runde Ausführung / Aircap round version	74,-			
2	AC-O-H-XXX-LB	Düse sechskant Ausführung / Tip hexagon version	50,-			
	AC-O-H-LB	Luftkappe sechskant Ausführung / Aircap hexagon version	74,-			

TYP "GR"

3	AC-GR-AA-XXX-LB	Düse / Tip - TYP „AA“	42,-			
	AC-GR-AF-XXX-LB	Düse mit Vorzerstäuber / Tip with preorifice - TYP „AF“	52,-			
	AC-GR-G4-XXX-LB	Düse / Tip - TYP „G4“	Siehe / Same as TYP "AA"			
	AC-GR-AA-LB	Luftkappe / Aircap - TYP „AA“	74,-			

TYP "KR"

4	AC-65-XXXX4-LB	Düse / Tip - TYP „KR“	42,-			
	AC-65-XXXX2-LB	Düse mit Vorzerstäuber / Tip with preorifice - TYP „KR“	52,-			
	AC-6524-LB	Luftkappe / Aircap - TYP „24“	74,-			

Düsendichtungen / Tip Seals

	AC-O-SEAL-LB	Passend / Fitting TYP "O-R" (10x)	5,80			
	AC-GR-SEAL-LB	Passend / Fitting TYP "GR" (10x)	5,80			
	AC-65-SEAL-LB	Passend / Fitting TYP "KR" (10x)	39,-			



1 LowBudget
TYP "W4"



3 LowBudget
Dichtung
Seal



4 LowBudget
Dichtring
Diffusor Seal



2 LowBudget
TYP "W47"



5 LowBudget
TYP "S"



AirCombi

Pos.	Art.-Nr. Part-No.	Artikelbeschreibung Description	Listenpreis	Netto-Stückpreis bei		
			List price	Net unit price for		
			€/Stück €/piece	1 Stück 1 piece	10 Stück 10 pieces	25 Stück 25 pieces

TYP "W"

1	AC-W4-XXX-LB	Düse Edelstahl / Tip stainless steel - TYP „3000/4500/4600/4700/M140“	44,-			
2	AC-W47-R-LB	Luftkappe rot / Aircap red - TYP „4500/4600/4700/M140“	74,-			
	AC-W47-B-LB	Luftkappe blau / Aircap blue - TYP „4500/4600/4700/M140“				

Dichtungen / Seals

3	AC-W4-SEAL-LB	Passend / Fitting TYP "W4"	4,48			
4	W394339-LB	Dichtring passend / Diffusor Seal fitting TYP "W4"	6,98			

TYP "S"

5	AC-S-XXX-LB	Düse / Tip - passend / fitting - SAGOLA	40,-			
	AC-SF-XXX-LB	Düse mit Vorzerstäuber passend / Tip with preorifice fitting - SAGOLA	50,-			

Dichtungen für Luftkappen / Seals for AirCaps

AC-O-CAP-SEAL	Passend / Fitting TYP "O-R"	0,90			
	Passend / Fitting TYP "O-H"				
AC-GR-NUT-SEAL	Passend / Fitting TYP "GR" (2x)	2,10			
AC-KR-NUT-SEAL	Passend / Fitting TYP "KR" (2x)				
AC-W-NUT-SEAL	Passend / Fitting TYP "W4" (2x)	4,50			

FILTER. AIRLESS. AIRCOMBI.

Produktion nach Maß!

- Hochdruck und Niederdruck
- Pistolenfilter
- Pumpenfilter
- Ansaugfilter und Filterscheiben
- Düsenfilter
- Becher- und Papierfilter
- Filtergehäuse
- Sonderanfertigungen
- Verpackung / Maschen / Label

Customised Production!

- High Pressure and Low Pressure
- Gun Filters
- Pump Filters
- Suction Filters and Filter Discs
- Tip Filters
- Cup Filters and Paper Strainers
- Filter Housings
- Special Types
- Packing / Mesh / Labelling

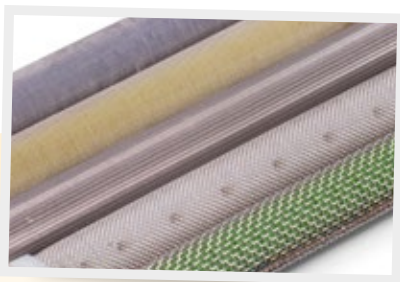

Maschen
Mesh



Label
Labelling



Verpackung
Packing

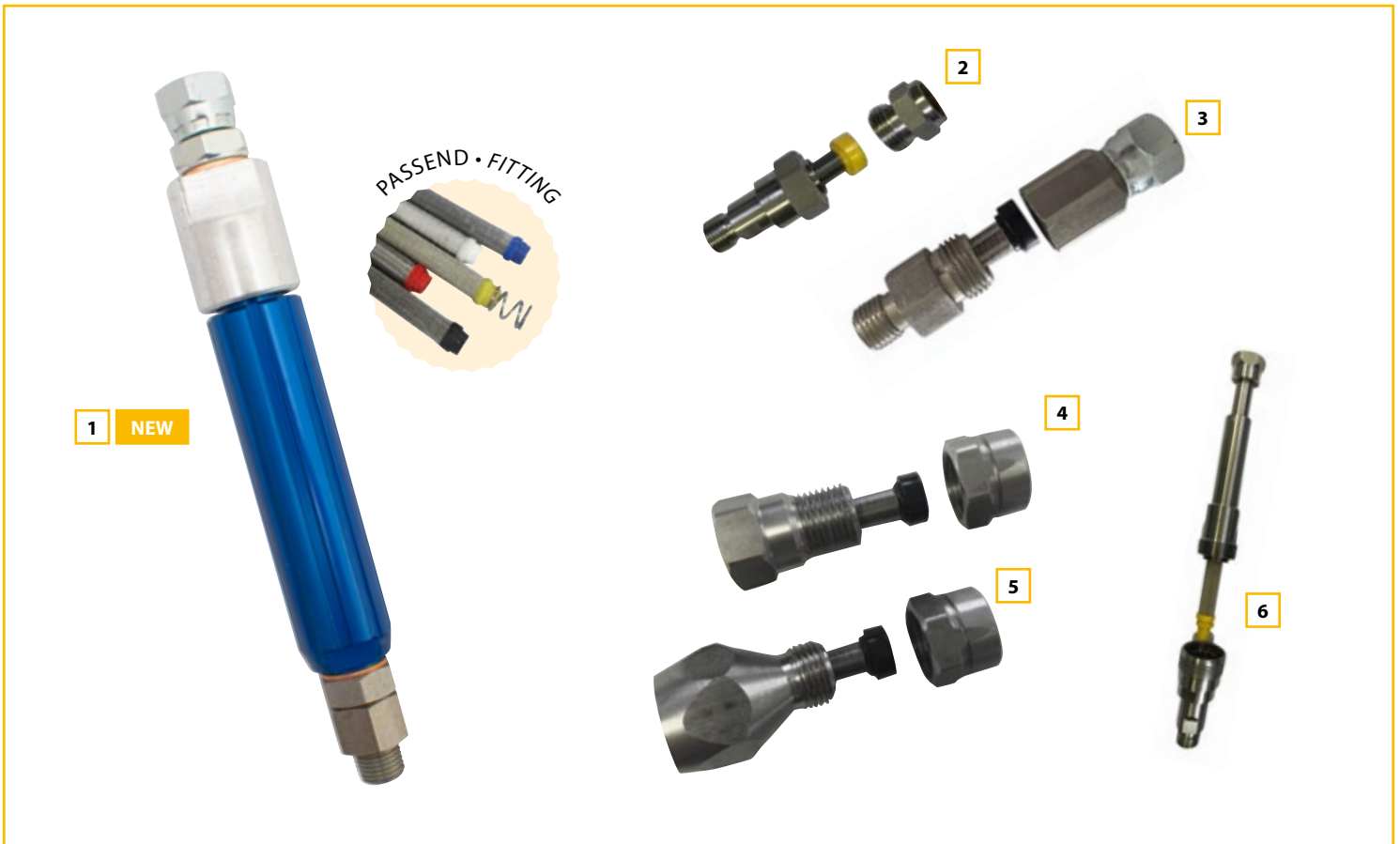

Filter-Gehäuse / Filter Housing

Pos.	Art.-Nr. Part-No.	Artikelbeschreibung Description	Listenpreis List price	Netto-Stückpreis bei Net unit price for		
			€/Stück €/piece	1 Stück 1 pieces	5 Stück 5 pieces	10 Stück 10 pieces

Einsteckfilter Lang / Insert Filter Long

1	HOSE-FI-1/4-B	Schlauch - Filtergehäuse kmpl. / Hose - Filter Housing cpl. - 1/4" BSP Adapter Alu	49,-			
	HOSE-FI-1/4-B-SS	Schlauch - Filtergehäuse kmpl. / Hose - Filter Housing cpl. - 1/4" BSP Adapter SS	59,-			

SPALT Filter

2	63004	Edelstahl / Stainless Steel - Mini - 1/4" AG (M) - 1/4" IG (F) - BSP	29,-			
	63014	Edelstahl / Stainless Steel - Mini - 1/4" AG (M) - 1/4" IG (F) - NPS				
3	107300	Edelstahl / Stainless Steel - 1/4" IG (F) - 1/4" AG (M) - NPS	39,-			
4	63006	Diffuser Filtergehäuse Edelstahl / Diffusor Filter Housing Stainless Steel - 11/16"	29,-			
5	63007	Diffuser Filtergehäuse Edelstahl / Diffusor Filter Housing Stainless Steel - 7/8"				

Einsteckfilter Lang / Insert Filter Long

6	63001	Edelstahl / Stainless Steel - 1/4" IG (F) - 1/4" AG (M) - BSP	58,-			
	63002	Edelstahl / Stainless Steel - 1/4" IG (F) - 3/8" AG (M) - BSP				

1 LowBudget
Passend / Fitting
 Diverse Marken
 Several Brands



2 WAGNER
CAGE FILTER
 GM4700



3 LowBudget
Passend / Fitting
 Titan



4 LowBudget
Passend / Fitting
 Optima



Pistolenfilter / Gun Filter

Pos.	Art.-Nr. Part-No.	Artikelbeschreibung Description	Listenpreis	Netto-Stückpreis bei		
			List price	Net unit price for		
			€/Stück	10 Stück	100 Stück	500 Stück
			€/piece	10 pieces	100 pieces	500 pieces

Einsteckfilter / Insert Filter

1	HS89323-LB	grün - 30 Maschen / green - 30 mesh	Mindestabnahme: 10 Stk. = Verpackungseinheit Minimum Order Quantity: 10 Pcs. = Packaging Unit	2,60			
	HS34377-LB	weiss - 50 Maschen / white - 50 mesh					
	HS34379-LB	schwarz - 70 Maschen / black - 70 mesh					
	HS43235-LB	gelb - 100 Maschen / yellow - 100 mesh		8,50			
	HS34382-LB	blau - 150 Maschen / blue - 150 mesh					
	HS34383-LB	rot - 200 Maschen / red - 200 mesh					
	HS300-LB	silber - 300 Maschen / silver - 300 mesh					
77113	Feder / Spring	1,80					
			€/Stück	1 Stück	10 Stück	30 Stück	
			€/piece	1 pieces	10 pieces	30 pieces	
2	W2315726	weiss - 50 Maschen (10 Stk.) / white - 50 mesh (10 pcs.)	20,-				
	W2315725	gelb - 100 Maschen (10 Stk.) / yellow - 100 mesh (10 pcs.)					
	W2315724	blau - 150 Maschen (10 Stk.) / blue - 150 mesh (10 pcs.)					
	W2315723	rot - 200 Maschen (10 Stk.) / red - 200 mesh (10 pcs.)					
			€/Stück	10 Stück	100 Stück	500 Stück	
			€/piece	10 pieces	100 pieces	500 pieces	
3	TIFI-60-LB	weiss - 60 Maschen / white - 60 mesh	Mindestabnahme: 10 Stk. = Verpackungseinheit Minimum Order Quantity: 10 Pcs. = Packaging Unit	4,90			
	TIFI-100-LB	gelb - 100 Maschen / yellow - 100 mesh					
	TIFI-150-LB	rot - 150 Maschen / red - 150 mesh					

Einschraubfilter / Screw-In

4	HS82008-LB	weiß - 80 Maschen / weiß - 80 mesh	Mindestabnahme: 10 Stk. = Verpackungseinheit Minimum Order Quantity: 10 Pcs. = Packaging Unit	6,50			
	HS82016-LB	gelb - 150 Maschen / yellow - 150 mesh					
	HS82030-LB	rot - 295 Maschen / red - 295 mesh		6,50			



1 LowBudget
Passend / Fitting
Graco

3 LowBudget
Passend / Fitting
Graco, Wagner, etc.



2 LowBudget
Passend / Fitting
Graco

Pistolenfilter / Gun Filter

Pos.	Art.-Nr. Part-No.	Artikelbeschreibung Description	Listenpreis List price	Netto-Stückpreis bei Net unit price for		
			€/Stück €/piece	10 Stück 10 pieces	50 Stück 50 pieces	100 Stück 100 pieces
1	GR218-50-LB	blau - 50 Maschen blue - 50 mesh	11,-			
	GR218-100-LB	rot - 100 Maschen red - 100 mesh				
			Mindestabnahme: 10 Stk. = Verpackungseinheit Minimum Order Quantity: 10 Pcs. = Packaging Unit			
2	GR287-60-LB	schwarz - 60 Maschen black - 60 mesh	7,80			
	GR287-100-LB	blau - 100 Maschen blue - 100 mesh				
	GR287-150-LB	orange - 150 Maschen orange - 150 mesh				
			Mindestabnahme: 10 Stk. = Verpackungseinheit Minimum Order Quantity: 10 Pcs. = Packaging Unit			

SPALT Filter Edelstahl / Stainless Steel

3	SPALT30-LB	rot - 30 Maschen red - 30 mesh	11,-			
	SPALT60-LB	weiss - 60 Maschen white - 60 mesh				
	SPALT80-LB	blau - 80 Maschen blue - 80 mesh				
	SPALT100-LB	schwarz - 100 Maschen black - 100 mesh				
	SPALT200-LB	gelb - 200 Maschen yellow - 200 mesh				
			Mindestabnahme: 10 Stk. = Verpackungseinheit Minimum Order Quantity: 10 Pcs. = Packaging Unit			
			18,-			

1 LowBudget

Passend / Fitting

GRACO
Ø 20 mm
H: 91 mm



2 LowBudget

Passend / Fitting

GRACO
Ø 31 mm
H: 114 mm

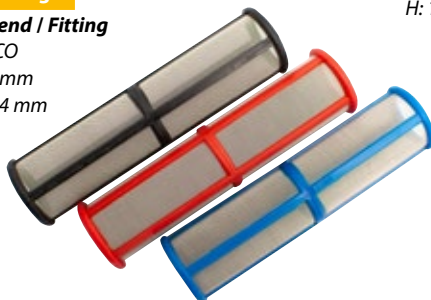

3 LowBudget

Passend / Fitting

GRACO
Ø 31 mm
H: 180 mm

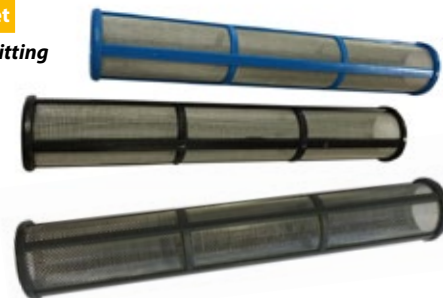

4 LowBudget

Passend / Fitting

GRACO
Ø 26,5 mm
H: 144 mm



5 LowBudget

Plastik
Plastic



7 NEW

Passend / Fitting

GRACO
Ø 27 mm
H: 144 mm



6 LowBudget

Aluminium

Hochdruckfilter / High Pressure Filter Typ "GR"

Pos.	Art.-Nr. Part-No.	Artikelbeschreibung Description	Listenpreis List price	Netto-Stückpreis bei Net unit price for		
			€/Stück €/piece	1 Stück 1 pieces	10 Stück 10 pieces	30 Stück 30 pieces
1	GR246-60-LB	kurz - schwarz - 60 Maschen / short - black - 60 mesh	22,-			
	GR246-100-LB	kurz - blau - 100 Maschen / short - blue - 100 mesh				
2	GR243-60-LB	mittel - schwarz - 60 Maschen / medium - black - 60 mesh	22,-			
	GR243-100-LB	mittel - blau - 100 Maschen / medium - blue - 100 mesh	22,-			
	GR243-200-LB	mittel - rot - 200 Maschen / medium - red - 200 mesh	22,-			
3	GR244-30-LB	lang - grau - 30 Maschen / long - grey - 30 mesh	25,-			
	GR244-60-LB	lang - schwarz - 60 Maschen / long - black - 60 mesh				
	GR244-100-LB	lang - blau - 100 Maschen / long - blue - 100 mesh				
4	HDFG-15-LB	15 Maschen / 15 mesh - 144 mm	8,10			
	HDFG-30-LB	30 Maschen / 30 mesh - 144 mm	7,10			
	HDFG-60-LB	60 Maschen / 60 mesh - 144 mm				
	HDFG-80-LB	80 Maschen / 80 mesh - 144 mm	8,10			
	HDFG-100-LB	100 Maschen / 100 mesh - 144 mm				
	HDFG-150-LB	150 Maschen / 150 mesh - 144 mm	8,50			
	HDFG-200-LB	200 Maschen / 200 mesh - 144 mm				
5	3000-K	Filterstütze Plastik / Filter support plastic	25,-			
6	3000-A	Filterstütze Aluminium / Filter support aluminium				

Hochdruckfilter-Gehäuse / High Pressure Filter Housing

7	HP-FI-LO-N	3/8" NPS (F) - 1/4" NPS (M) - Edelstahl / Stainless Steel	€/Stück €/piece	1 Stück 1 pieces	5 Stück 5 pieces	10 Stück 10 pieces
			164,-			

1 LowBudget

Passend / Fitting
WAGNER
Ø 27 mm
H: 144 mm



3 LowBudget

Passend / Fitting
WAGNER ProSpray



2 LowBudget

Ø 22 mm
H: 141 mm



5 LowBudget

Passend / Fitting
Wagner HC-LC
Titan Speeflow



4 LowBudget

Passend / Fitting
WAGNER TYP F



6 NEW

Passend / Fitting
WAGNER
Ø 27 mm
H: 144 mm



Hochdruckfilter / High Pressure Filter Typ "W"

Pos.	Art.-Nr. Part-No.	Artikelbeschreibung Description	Listenpreis / Net unit price for			
			€/Stück €/piece	1 Stück 1 piece	10 Stück 10 pieces	30 Stück 30 pieces
1	W351-20-LB	20 Maschen / 20 mesh - 144 mm	19,-			
	W351-50-LB	50 Maschen / 50 mesh - 144 mm				
	W351-100-LB	100 Maschen / 100 mesh - 144 mm				
	W351-200-LB	200 Maschen / 200 mesh - 144 mm				
2	W989-SS-LB	Filterstütze Edelstahl / Filter support stainless steel	8,60			
3	W508-30-LB	30 Maschen / 30 mesh - ProSpray	13,-			
	W508-60-LB	60 Maschen / 60 mesh - ProSpray				
	W508-100-LB	100 Maschen / 100 mesh - ProSpray				
4	T500-60-LB	Schwarz - 60 Maschen / black - 60 mesh	17,-			
	T500-100-LB	Weiß - 100 Maschen / white - 100 mesh				
5	W349-50-LB	50 Maschen / 50 mesh	39,-			

Hochdruckfilter-Gehäuse / High Pressure Filter Housing

Pos.	Art.-Nr. Part-No.	Artikelbeschreibung Description	Listenpreis / Net unit price for			
			€/Stück €/piece	1 Stück 1 piece	5 Stück 5 pieces	10 Stück 10 pieces
6	HP-FI-LO-N	3/8" NPS (F) - 1/4" NPS (M) Edelstahl ohne Filter und Stütze / Stainless Steel without Filter and Support	164,-			
	HP-FI-LO-M	3/8" NPS (F) - M16x1.5 (M) Edelstahl ohne Filter und Stütze / Stainless Steel without Filter and Support				

1 LowBudget

Passend / Fitting
 Kremlin, Böllhoff, etc.
 Ø 27 mm
 H: 114 mm



2 LowBudget

Ø 21 mm
 H: 114 mm



3 LowBudget

Passend / Fitting
 Larius, Taiver
 Ø 26,5 mm
 H: 144 mm

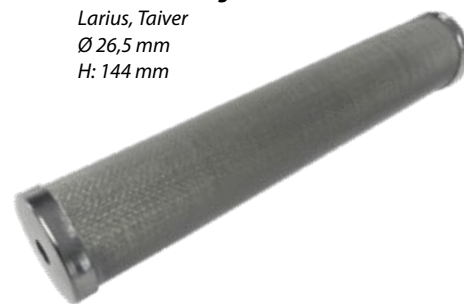

Hochdruckfilter / High Pressure Filter

Pos.	Art.-Nr. Part-No.	Artikelbeschreibung Description	Listenpreis List price	Netto-Stückpreis bei Net unit price for		
			€/Stück €/piece	1 Stück 1 pieces	10 Stück 10 pieces	30 Stück 30 pieces
1	HDF02-LB	Nr. 2 - 200 Maschen / No. 2 - 200 mesh	9,-			
	HDF03-LB	Nr. 3 - 180 Maschen / No. 3 - 180 mesh				
	HDF04-LB	Nr. 4 - 165 Maschen / No. 4 - 165 mesh				
	HDF05-LB	Nr. 5 - 100 Maschen / No. 5 - 100 mesh				
	HDF06-LB	Nr. 6 - 80 Maschen / No. 6 - 80 mesh				
	HDF09-LB	Nr. 9 - 60 Maschen / No. 9 - 60 mesh				
	HDF12-LB	Nr. 12 - 50 Maschen / No. 12 - 50 mesh				
	HDF15-LB	Nr. 15 - 30 Maschen / No. 15 - 30 mesh				
	HDF20-LB	Nr. 20 - 20 Maschen / No. 20 - 20 mesh				
2	FIU-S-LB	Filterstütze Edelstahl / filter support stainless steel	8,30			
3	HDF-L/T-30	Ohne Flügel - 30 Maschen / Without wings - 30 mesh	6,90			
	HDF-L/T-60	Ohne Flügel - 60 Maschen / Without wings - 60 mesh				
	HDF-L/T-100	Ohne Flügel - 100 Maschen / Without wings - 100 mesh				
	HDF-L/T-150	Ohne Flügel - 150 Maschen / Without wings - 150 mesh				
	HDF-L/T-200	Ohne Flügel - 200 Maschen / Without wings - 200 mesh				

1 LowBudget

Passend / Fitting
WIWA
Ø 26 mm
H: 53 mm



2 LowBudget

Passend / Fitting
WIWA
Ø 33,5 mm
H: 130 mm

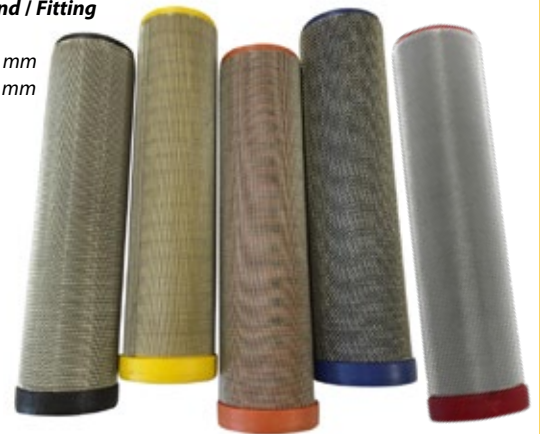

3 LowBudget

Passend / Fitting
Binks, WIWA
Ø 32 mm
H: 61,5 mm



4 LowBudget

Passend / Fitting
Binks, WIWA
Ø 32 mm
H: 99,5 mm



Hochdruckfilter / High Pressure Filter

Pos.	Art.-Nr. Part-No.	Artikelbeschreibung Description	Listenpreis List price	Netto-Stückpreis bei Net unit price for		
			€/Stück €/piece	1 Stück 1 piece	10 Stück 10 pieces	30 Stück 30 pieces
1	HDW-50-LB	orange - 50 Maschen / orange - 50 mesh	5,-			
	HDW-70-LB	gelb - 70 Maschen / yellow - 70 mesh				
	HDW-100-LB	schwarz - 100 Maschen / black - 100 mesh				
	HDW-150-LB	rot - 150 Maschen / red - 150 mesh				
	HDW-200-LB	weiss - 200 Maschen / white - 200 mesh				
2	HDW162-150-LB	rot - 150 Maschen / red - 150 mesh	9,-			
	HDW162-100-LB	schwarz - 100 Maschen / black - 100 mesh				
	HDW162-70-LB	gelb - 70 Maschen / yellow - 70 mesh				
	HDW162-50-LB	orange - 50 Maschen / orange - 50 mesh				
	HDW162-30-LB	blau - 30 Maschen / blue - 30 mesh				
3	HDH-II-50-LB	50 Maschen - Edelstahl / 50 mesh - stainless steel - TYP II	20,-			
	HDH-II-100-LB	100 Maschen - Edelstahl / 100 mesh - stainless steel - TYP II				
4	HDH-III-100-LB	100 Maschen - Edelstahl / 100 mesh - stainless steel - TYP III	30,-			
	HDH-III-50-LB	50 Maschen - Edelstahl / 50 mesh - stainless steel - TYP III				

1 HEXAGON



2 ROUND



3 MINI

Ø 27 mm
H: 31 mm



4 LowBudget

Ø 22 mm / Ø 28 mm
H: 130 mm



5 LowBudget

Passend / Fitting
Graco



6



7

M25x1
Ø 35 mm

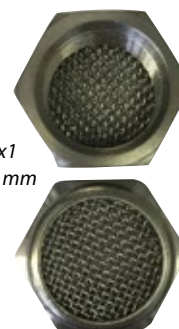

Ansaugfilter / Suction Filter

Pos.	Art.-Nr. Part-No.	Artikelbeschreibung Description	Listenpreis List price	Netto-Stückpreis bei Net unit price for		
			€/Stück €/piece	1 Stück 1 piece	10 Stück 10 pieces	30 Stück 30 pieces
1	AF-H-15-XXX	15 Maschen / 15 Mesh - 1/2" / 3/4" / 1" / M28 / M38 - Hexagon	18,-			
	AF-H-30-XXX	30 Maschen / 30 Mesh - M15 / M28 - Hexagon				
2	ANF-R-15-XXX	15 Maschen / 15 Mesh - 1/2" / 3/4" / 1" / M15 / M28 - Round	10,-			
	ANF-R-30-XXX	30 Maschen / 30 Mesh - 1/2" / 3/4" / 1" / M15 / M28 / M38 - Round				
	ANF-R-60-XXX	60 Maschen / 60 Mesh - 1/2" / M15 / M28 - Round				
3	ANF-MINI-1/2	30 Maschen / 30 Mesh - 1/2"	10,-			
	ANF-MINI-M15	30 Maschen / 30 Mesh - M15				
4	2011101	grob / rough - Ø 28	20,-			
	2011102	fein / smooth - Ø 28				
	2011103	grob / rough - Ø 22				
	2011104	fein / smooth - Ø 22				
5	AF-GR-7/8-LB	7/8" - ST MAX 395/495	23,-			
	AF-GR-3/4-LB	3/4" - 390ST/490ST/395ST/495ST				
	AF-GR-1-LB	1" - MARK/MAX				
6	W97531-LB	Filterbeutel / Filter bag - ca. 300 µ	5,90			
7	SPUND-FI	Spundfilter / Bung filter	11,-			

1 LowBudget



3 LowBudget

Ø 51 / 57 / 59 / 87 / 140 mm

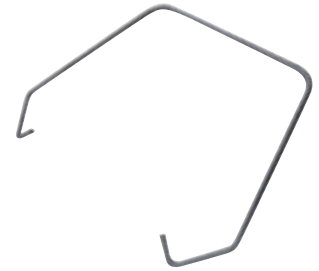

2 LowBudget

Ø 87 mm
Ø 82 mm



4 LowBudget

Ø 51 / 57 / 59 mm



5 LowBudget

Ø 140 mm



6 LowBudget

Passend / Fitting
6 Ltr. Oberbehälter / Hopper
Ø 87 mm



Filterglocken & -scheiben / Suction Housings & Filter Discs

Pos.	Art.-Nr. Part-No.	Artikelbeschreibung Description	Listenpreis List price	Netto-Stückpreis bei Net unit price for		
			€/Stück €/piece	1 Stück 1 piece	10 Stück 10 pieces	30 Stück 30 pieces
1	FG-KPL-M15-LB	Filterglocke kpl. / Filter housing cpl. - M15x1	5,-			
	FG-KPL-1/2-LB	Filterglocke kpl. / Filter housing cpl. - 1/2"				
2	FD-87-50-LB	Filterscheibe weiß / Filter disc white - D87 - 50 mesh	2,-			
	FD-82-100-LB	Filterscheibe gelb / Filter disc yellow - D82 - 100 mesh				
3	SR87-LB	Sprengring Edelstahl / Snap ring stainless steel	2,50			
4	FD-51-XX-LB	Filterscheibe - 20/40 Maschen - D51 Filter disc - 20/40 mesh - D51	3,-			
	FD-57-XX-LB	Filterscheibe - 20/40 Maschen - D57 Filter disc - 20/40 mesh - D57				
	FD-59-XXX-LB	Filterscheibe Edelstahl 20/50 Maschen - D59 Filter disc stainless steel 20/50 mesh - D59				
5	FD-140-XX-LB	Filterscheibe Edelstahl - 20/50/70 Maschen - D140 Filter disc stainless steel - 20/50/70 mesh - D140	10,-			
3	SR-XX-LB	Sprengring Edelstahl / Snap ring stainless steel - D51/57/59	3,-			
	SR140-LB	Sprengring Edelstahl / Snap ring stainless steel - D140	6,-			
6	FI-HÜ	Filterscheibe 20 Maschen / Filter disc 20 mesh - D87 (6 ltr.)	2,50			

1 LowBudget
Passend / Fitting
Kremlin



2 LowBudget
Passend / Fitting
Kremlin



3 LowBudget
Faltfilter
Paper Strainer

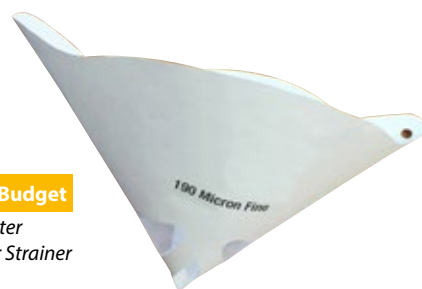

Pos.	Art.-Nr. Part-No.	Artikelbeschreibung Description	Listenpreis List price	Netto-Stückpreis bei Net unit price for		
			€/Stück €/piece	1 Stück 1 piece	10 Stück 10 pieces	30 Stück 30 pieces

Düsenfilter / Tip Filter

1	KR-TIP-75-LB	Micro-Filter 75 Maschen (10 Stück) Micro filter 75 mesh (10 pieces)	9,-			
	KR-TIP-100-LB	Micro-Filter 100 Maschen (10 Stück) Micro filter 100 mesh (10 pieces)				
	KR-TIP-140-LB	Micro-Filter 140 Maschen (10 Stück) Micro filter 140 mesh (10 pieces)				

Pistolenfilter / Gun Filter

2	KR-4-50-LB	Ersatzfilter lang - 50 Maschen (5 Stück) Replacement filter long - 50 mesh (5 pieces)	1,60			
	KR-4-60-LB	Ersatzfilter lang Nr. 12 - 60 Maschen (5 Stück) Replacement filter long No. 12 - 60 mesh (5 pieces)				
	KR-4-85-LB	Ersatzfilter lang Nr. 6 - 85 Maschen (5 Stück) Replacement filter long No. 6 - 85 mesh (5 pieces)				
	KR-4-100-LB	Ersatzfilter lang - 100 Maschen (5 Stück) Replacement filter long - 100 mesh (5 pieces)				
	KR-4-140-LB	Ersatzfilter lang Nr. 4 - 140 Maschen (5 Stück) Replacement filter long No. 4 - 140 mesh (5 pieces)				

Faltfilter / Paper Strainer

3	PAPER-FI-125-LB	125 µ (1.000 Stück / pieces)	72,-	1 Stück 1 piece	5 Stück 5 pieces	10 Stück 10 pieces
	PAPER-FI-190-LB	190 µ (1.000 Stück / pieces)				

1 LowBudget

Filtergehäuse
Filter Housing
1/4"
3/8"



3 LowBudget

Passend / Fitting
Fließbecher
Gravity Cup



5 LowBudget

Passend / Fitting
Saugbecher
Suction Cup
Ø 29 mm



2 LowBudget



4 LowBudget

Passend / Fitting
Saugbecher
Suction Cup
Ø 19 mm



Pos.	Art.-Nr. Part-No.	Artikelbeschreibung Description	Listenpreis	Netto-Stückpreis bei		
			List price	Net unit price for		
			€/Stück €/piece	1 Stück 1 piece	10 Stück 10 pieces	30 Stück 30 pieces

Niederdruck- und Becherfilter / Low Pressure and Cup Filter

1	NDF-FG-1/4-LB	Delrin - 1/4" NPS (M) x 1/4" NPS (F)	20,-			
	NDF-FG-3/8-LB	Delrin - 3/8" NPS (M) x 3/8" NPS (F)	25,-			
	NDF-FG-3/8-SS-LB	Edelstahl / stainless steel - 3/8" NPS (M) x 3/8" NPS (F)	30,-			

2	NDF-50-LB	Weiß - 50 Maschen / white - 50 mesh	2,-	10 Stück 10 pieces	50 Stück 50 pieces	100 Stück 100 pieces
	NDF-110-LB	Blau - 110 Maschen / blue - 110 mesh				
	NDF-180-LB	Rot - 180 Maschen / red - 180 mesh				
	NDF-250-LB	Grün - 250 Maschen / green - 250 mesh				
	NDF-450-LB	Orange - 450 Maschen / orange - 450 mesh				

3	35155-60-NY-LB	60 Maschen - Nylon / 60 mesh - Nylon	1,50			
	35155-60-SS-LB	60 Maschen - Edelstahl / 60 mesh - Stainless Steel				
	35155-100-NY-LB	100 Maschen - Nylon / 100 mesh - Nylon				
	35155-100-SS-LB	100 Maschen - Edelstahl / 100 mesh - Stainless Steel				

4	35166-100-NY-LB	100 Maschen - Nylon / 100 mesh - Nylon - D19	1,80			
	35166-100-SS-LB	100 Maschen - Edelstahl / 100 mesh - Stainless Steel - D19				

5	3517700-NY-LB	130 Maschen - Nylon / 130 mesh - Nylon - D29	1,80			
	3517700-SS-LB	130 Maschen - Edelstahl / 130 mesh - Stainless Steel - D29	2,-			

AIR. AIRLESS. AIRCOMBI.

Produktion nach Maß!

- Hochdruck und Niederdruck
- Fertig konfektioniert
- Rollenware
- Schlauchanschlüsse
- Doppelschläuche
- Heizschläuche

Customised Production!

- High Pressure and Low Pressure
- Already assembled
- In bulk on reel
- Hose-Fittings
- Tandem Hoses
- Heated Hoses



Rollenware
In bulk on reel



Schlauchanschlüsse
Hose-Fittings



Heizschläuche
Heated Hoses

1 BLUE
Textilgeflecht
Textile Braided

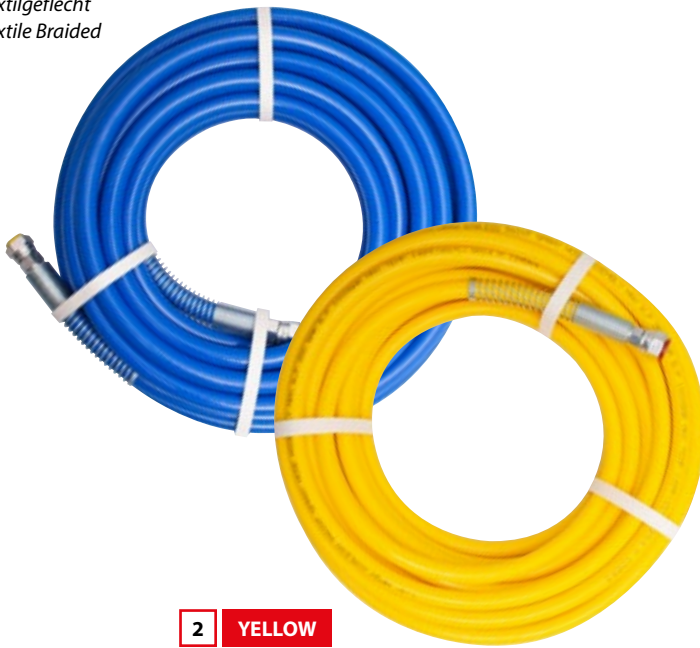

2 YELLOW
Textilgeflecht
Textile Braided

3 BLACK
1x Stahlgeflecht
1x Wire Braided



Hochdruckschläuche / High Pressure Hoses

Pos.	Art.-Nr. Part-No.	Artikelbeschreibung Description	Listenpreis List price	Netto-Stückpreis bei Net unit price for			
				€/Stück €/piece	5 Stück 5 pieces	10 Stück 10 pieces	30 Stück 30 pieces
Textil / Textile - 250 Bar							
Blau / Blue							
1	H-T-3/16-7.5-SS-NP	3/16" - 7.5 Meter - 1/4" NPS - Edelstahl / Stainless Steel	Mindestabnahme: 5 Stk. Minimum Order Quantity: 5 Pcs.	39,-			
	H-T-1/4-15-NP	1/4" - 15 Meter - 1/4" NPS		54,-			
	H-T-3/8-15-NP	3/8" - 15 Meter - 3/8" NPS		99,-			
Gelb / Yellow							
2	H-T-1/4-15-YE-NP	1/4" - 15 Meter - 1/4" NPS	Mindestabnahme: 5 Stk. Minimum Order Quantity: 5 Pcs.	54,-			
	H-T-3/8-15-YE-NP	3/8" - 15 Meter - 3/8" NPS		99,-			
1x Stahl / 1x Wire - 350 Bar							
Schwarz / Black							
3	H-W1-1/4-15-NP	1/4" - 15 Meter - 1/4" NPS	Mindestabnahme: 5 Stk. Minimum Order Quantity: 5 Pcs.	58,-			

4x Sicherheitsfaktor • Elektrisch leitfähig
4x Safety factor • Electric conductive

2x Textilgeflecht - Hochdruck (bis 260 Bar) - 4x Sicherheitsfaktor
 2x Textile Braided - High Pressure (up to 260 Bar) - 4x Safety Factor



Konfektioniert Textil / Assembled Textile

Art.-Nr. Part-No.	Artikelbeschreibung Description	Listenpreis List price	Netto-Stückpreis bei Net unit price for		
		€/Stück €/piece	1 Stück 1 piece	5 Stück 5 pieces	10 Stück 10 pieces
T-3/16-1.5	3/16" - 250 Bar - 1.5 Meter - 1/4" NPS (F) x (M)	19,-			
T-3/16-1.5-SS	3/16" - 250 Bar - 1.5 Meter - 1/4" NPS (F) x (M) - Edelstahl / Stainless Steel	39,-			
T-3/16-7.5	3/16" - 250 Bar - 7.5 Meter - 1/4" NPS	44,-			
T-3/16-7.5-SS	3/16" - 250 Bar - 7.5 Meter - 1/4" NPS - Edelstahl / Stainless Steel	58,-			
T-3/16-7.5M-SS	3/16" - 250 Bar - 7.5 Meter - M16x1.5 - Edelstahl / Stainless Steel	58,-			
T-3/16-7.5-J-SS-YE	3/16" - 250 Bar - 7.5 Meter - 1/2" JIC - Edelstahl / Stainless Steel	58,-			
T-3/16-10-SS	3/16" - 250 Bar - 10 Meter - 1/4" NPS - Edelstahl / Stainless Steel	68,-			
T-3/16-15-SS	3/16" - 250 Bar - 15 Meter - 1/4" NPS - Edelstahl / Stainless Steel	79,-			
T-1/4-1.5	1/4" - 260 Bar - 1.5 Meter - 1/4" NPS (F) x (M)	24,-			
T-1/4-1.5-SS	1/4" - 260 Bar - 1.5 Meter - 1/4" NPS (F) x (M) - Edelstahl / Stainless Steel	39,-			
T-1/4-15	1/4" - 260 Bar - 15 Meter - 1/4" NPS	64,-			
T-1/4-15M	1/4" - 260 Bar - 15 Meter - M16x1.5	64,-			
T-3/8-1.5-SS	3/8" - 260 Bar - 1.5 Meter - 3/8" NPS (F) x (M) - Edelstahl / Stainless Steel	54,-			
T-3/8-1.5-SS-4	3/8" - 260 Bar - 1.5 Meter - 1/4" NPS (F) x 3/8" (M) - Edelstahl / Stainless Steel	54,-			
T-3/8-15	3/8" - 260 Bar - 15 Meter - 3/8" NPS	124,-			
T-3/8-15-SS	3/8" - 260 Bar - 15 Meter - 3/8" NPS - Edelstahl / Stainless Steel	134,-			
T-3/8-15-SS-YE	3/8" - 260 Bar - 15 Meter - 3/8" NPS - gelb - Edelstahl / yellow - Stainless Steel	134,-			
T-3/8-30-SS	3/8" - 260 Bar - 30 Meter - 3/8" NPS - Edelstahl / Stainless Steel	219,-			
T-1/2-15-SS	1/2" - 260 Bar - 15 Meter - 1/2" NPS - blau - Edelstahl / blue - Stainless Steel	268,-			
T-1/2-15-SS-YE	1/2" - 260 Bar - 15 Meter - 1/2" NPS - gelb - Edelstahl / yellow - Stainless Steel				

1x & 2x Stahlgeflecht - Hochdruck (bis 450 Bar) - 4x Sicherheitsfaktor
 1x & 2x Wire Braided - High Pressure (up to 450 Bar) - 4x Safety Factor



Konfektioniert 1x Stahl / Assembled 1x Wire

Art.-Nr. Part-No.	Artikelbeschreibung Description	Listenpreis List price	Netto-Stückpreis bei Net unit price for		
		€/Stück €/piece	1 Stück 1 piece	5 Stück 5 pieces	10 Stück 10 pieces
W1-3/16-15SMF	3/16" - 350 Bar - 1 Meter - 1/4 NPS (F) x (M) - Edelstahl / Stainless Steel	34,-			
W1-3/16-7.5	3/16" - 350 Bar - 7.5 Meter - 1/4" NPS	49,-			
W1-3/16-7.5M	3/16" - 350 Bar - 7.5 Meter - M16x1.5				
W1-1/4-10	1/4" - 325 Bar - 10 Meter - 1/4" NPS	59,-			
W1-1/4-10-M	1/4" - 325 Bar - 10 Meter - M16x1.5				
W1-1/4-15	1/4" - 325 Bar - 15 Meter - 1/4" NPS	74,-			
W1-1/4-15M	1/4" - 325 Bar - 15 Meter - M16x1.5				
W1-3/8-15	3/8" - 250 Bar - 15 Meter - 3/8" NPS	98,-			
W1-3/8-30	3/8" - 250 Bar - 30 Meter - 3/8" NPS	186,-			

Konfektioniert 2x Stahl / Assembled 2x Wire

W2-1/4-10-SS	1/4" - 450 Bar - 10 Meter - 1/4" NPS - Edelstahl / Stainless Steel	98,-			
W2-1/4-12-SS	1/4" - 450 Bar - 12 Meter - 1/4" NPS - Edelstahl / Stainless Steel	119,-			
W2-1/4-15	1/4" - 450 Bar - 15 Meter - 1/4" NPS	98,-			
W2-3/8-15	3/8" - 428 Bar - 15 Meter - 3/8" NPS	139,-			
W2-3/8-30	3/8" - 428 Bar - 30 Meter - 3/8" NPS	238,-			

Stahlschläuche **ohne Knickschutzfedern**
 Wire Braided Hoses **without Spring Guards**

1
Niederdruck
Low Pressure



2



3
Hochdruck
High Pressure



Pos.	Art.-Nr. Part-No.	Artikelbeschreibung Description	Listenpreis List price	Netto-Stückpreis bei Net unit price for		
			€/Stück €/piece	50 Meter 50 meter	100 Meter 100 meter	250 Meter 250 meter

Niederdruckschlauch - elektrisch leitfähig - lösemittelbeständig Low Pressure Hose - electroconductive - solvent resistant

1	TPU20-6	6x10 mm - 20 Bar Arbeitsdruck / working pressure (Rolle / Reel = 50 m)	6,30			
	TPU20-13	13x19 mm - 20 Bar Arbeitsdruck / working pressure (Rolle / Reel = 50 m)	8,90			

Gewebeschutzschlauch / Protection Hose

2	GW30	24-36 mm (Rolle/Reel = 50/100/250m)	5,40			
	GW40	32-47 mm (Rolle/Reel = 50/100/250m)	7,80			

Material- und Luftschlauch - Im Gewebeschutzschlauch - Konfektioniert Material and Air Hose - In Protection Hose - Assembled

			€/Stück €/piece	1 Stück 1 piece	5 Stück 5 pieces	10 Stück 10 pieces
3	HTH-T-3/16-7.5-SS	3/16" - 7.5 m - 1/4" NPS - SS	169,-			
	HTH-T-3/16-7.5M-SS	3/16" - 7.5 m - M16x1.5-SS				
	HTH-T-3/16-7.5J-SS	3/16" - 7.5 m - 1/2" JIC - SS				
	HTH-T-3/16-10-SS	3/16" - 10 m - 1/4" NPS - SS	193,-			
	HTH-T-3/16-10M-SS	3/16" - 10 m - M16x1.5-SS				
	HTH-T-3/16-10J-SS	3/16" - 10 m - 1/2" JIC - SS				
	HTH-T-3/16-15-SS	3/16" - 15 m - 1/4" NPS - SS	235,-			
	HTH-T-3/16-15J-SS	3/16" - 15 m - 1/2" JIC - SS				



Hochdruck Verbindungsrippel / High Pressure Nipples - 500 Bar

Pos.	Art.-Nr. Part-No.	Artikelbeschreibung Description	Listenpreis	Netto-Stückpreis bei		
			List price	Net unit price for		
			€/Stück €/piece	1 Stück 1 piece	10 Stück 10 pieces	25 Stück 25 pieces
1	M1/4NXM1/4N	1/4" NPS (M) x 1/4" NPS (M)	4,40			
	M1/4NXM1/4N-SS	1/4" NPS (M) x 1/4" NPS (M) - SS	10,-			
	M1/4NXM3/8N	1/4" NPS (M) x 3/8" NPS (M)	4,40			
	M1/4NXM3/8N-SS	1/4" NPS (M) x 3/8" NPS (M) - SS	10,-			
	M1/4BXM1/4B	1/4" BSP (M) x 1/4" BSP (M)	4,40			
	M1/4BXM1/4B-SS	1/4" BSP (M) x 1/4" BSP (M) - SS	10,-			
1	M16XM1/4N	M16x1.5 (M) x 1/4" NPS (M)	7,50			
	M16XM1/4N-SS	M16x1.5 (M) x 1/4" NPS (M) - SS	10,-			
	M16XM1/4B	M16x1.5 (M) x 1/4" BSP (M)	7,50			
	M16XM16	M16x1.5 (M) x M16x1.5 (M)	7,50			
	M16xM16-SS	M16x1.5 (M) x M16x1.5 (M) - SS	10,-			
1	M3/8NXM16	3/8" NPS (M) x M16x1.5 (M)	7,50			
	M3/8NXM16-SS	3/8" NPS (M) x M16x1.5 (M) - SS	10,-			
	M3/8NXM3/8N	3/8" NPS (M) x 3/8" NPS (M)	7,50			
	M3/8NXM3/8N-SS	3/8" NPS (M) x 3/8" NPS (M) - SS	10,-			
	M3/8NXM1/2N-SS	3/8" NPS (M) x 1/2" NPS (M) - SS	10,-			
1	M1/2NXM1/2N-SS	1/2" NPS (M) x 1/2" NPS (M) - SS	10,-			

HEATING. MICRO. 4000.



MICRO STEUERUNG!

- Konstante Fix-Temperatur von 55°C unabhängig von Außentemperatur, Material und Düsengröße
- Sehr leichte Anwendung
- Direktanschluss an die Pumpe
- Kein separates Steuergerät/-kabel
- Einhaltung der VOC-Richtlinien
- Reduzierung der Viskosität
- Für wasser- und lösemittelhaltige Spritzmedien (Flammpunkt über 21°C)
- Auch für 2K-Materialien
- Adaptierbar an alle Airless-Geräte (Herstellervorgaben beachten)
- System steuert sich eigenständig – Keine Programmierung notwendig

MICRO CONTROL!

- *Continual fix-temperature of 55°C independent of outside temperature, coating material and tip size*
- *Very easy to use*
- *Direct connection to the pump*
- *No separate control-unit/-cable*
- *In compliance with VOC-regulations*
- *Reduction of viscosity*
- *Suitable for solvent and water-based Material (flash point over 21°C)*
- *Also for 2-component material*
- *Adaptable to all Airless-Pumps (attend to manufacturer`s specifications)*
- *System is independently self-controlled*
- *No programming necessary*



Heizschlauchserie MICRO 4000 / Heated Hose Series MICRO 4000 - 250 Bar

Art.-Nr. Part-No.	Artikelbeschreibung Description	Listenpreis List price	Netto-Stückpreis bei Net unit price for		
		€/Stück €/piece	1 Stück 1 piece	3 Stück 3 pieces	10 Stück 10 pieces
G-HH-7.5-55	Textil / Textile - 5/16" - 55°C - 7,5 m	1.490,-			
G-HH-15-55	Textil / Textile - 3/8" - 55°C - 15 m	1.890,-			

HEATING. ADJUSTABLE. 3000.



TEMPERATUR REGELBAR!

- Beheiztes Schlauch-System passend für alle Airless-Geräte
- Stufenlose Temperaturregelung von 20°- 80°C
- Einhaltung der VOC-Richtlinien (Stufe 2)
- Erwärmung des Spritzmediums reduziert die Viskosität
 - = Perfekte Beschichtung, auch an den Kanten
 - = Weniger/keine Lösungsmittel notwendig
 - = Wesentlich weniger Farnebel
 - = Erhöhung der Zerstäubungsqualität und des Auftragswirkungsgrades
- Geeignet auch für 2-Komponenten-Materialien
- Bessere Verarbeitung höherviskoser Beschichtungsmaterialien
- Für wasser- und lösemittelhaltige Spritzmedien (Flammpunkt über 21°C)
- Beheiztes Schlauch-System ermöglicht den Einsatz kleinerer Airless-Pumpen und somit weniger Anschaffungs- und Betriebskosten

TEMPERATURE ADJUSTABLE!

- Heated hose system adaptable to all Airless pumps
- Infinitely adjustable temperature 20°- 80°C
- In compliance with VOC-regulations (level 2)
- Heating of material reduces viscosity of paint drastically
 - = Vastly improved coating-results, even at edges
 - = Little/no solvent needed to be added to paint
 - = Reduced overspray
 - = Increasing of diffusion quality and the application result
- Suitable for 2-component materials
- Better processing of high viscosity coating materials
- Suitable for solvent and water-based materials (flash point over 21°C)
- Heated-hose-system reduces the need for larger Airless-units which means less investment, less expenses

Heizschlauchserie 3000 / Heated Hose Series 3000 - 250 Bar

Art.-Nr. Part-No.	Artikelbeschreibung Description	Listenpreis List price	Netto-Stückpreis bei Net unit price for		
			1 Stück 1 piece	3 Stück 3 pieces	10 Stück 10 pieces
G-HH-T-7.5-5/16	Textil / Textile - 5/16" - 7.5 m	€1.690,- €/piece			
G-HH-T-15	Textil / Textile - 3/8" - 15 m	€2.040,-			
G-HH-T-30	Textil / Textile - 3/8" - 30 m	€2.180,-			

LOW PRESSURE. AIR. MANUAL.

Wir liefern...

- Luftpistolen (Hand/Automatik)
- Spezialpistolen
- Umfangreiches Zubehör

...folgender Marken:

- PRONA
- AirGuns / IWATA
- SATA
- DEVILBISS

We supply...

- Air Guns (Manual/Automatic)
- Special Guns
- Wide range of accessories

...of following Brands:

- PRONA
- AirGuns / IWATA
- SATA
- DEVILBISS



Detaillierte
Technische Informationen
und weitere Modelle finden
Sie im separaten Katalog

Find detailed
technical information
and further Products in
separate catalogue

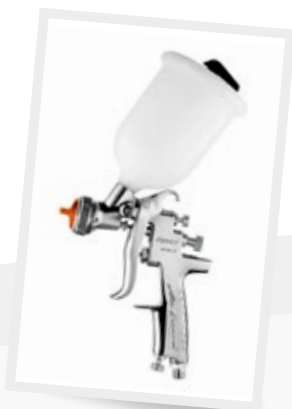

AirGuns / IWATA
Auf Anfrage / On Request

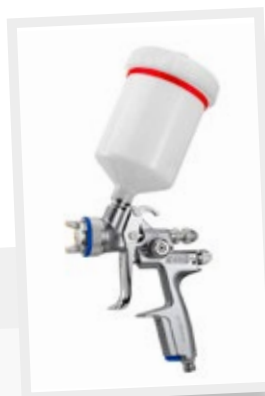

SATA
Auf Anfrage / On Request



DEVILBISS
Auf Anfrage / On Request



1 PRONA
GR-71E



2 PRONA



3 PRONA
GR-77

PRONA

Pos.	Art.-Nr. Part-No.	Artikelbeschreibung Description	Listenpreis	Netto-Stückpreis bei		
			List price	Net unit price for		
			€/Stück	1 Stück	5 Stück	10 Stück
			€/piece	1 piece	5 pieces	10 pieces
GR-71E						
1	GR-71E-XX	Luftpistole / Air Gun - 1.0/1.3/1.5/1.8 mm	98,-			
	GR-71E-NXX	Düsen-/Nadel-Set / Nozzle-/Needle-Set - 1.0/1.3/1.5/1.8 mm	29,-			
	GR-71E-CXX	Luftkappe / AirCap - 1.0/1.3/1.5/1.8 mm	26,-			
2	G-SET-RT-71	Luftpistolen-Drucktank-Set Drucktank 2 Ltr., Schlauchpaket 1/4" - 2,5 m, Luftpistole GR71E Air Gun Pressure Tank Set Pressure Tank 2 ltr., Hose Set 1/4" - 2,5 m, Air Gun GR71E	289,-			

GR-77

3	GR-77-XX	Luftpistole / Air Gun - 1.2/1.5/2.0/2.5/3.0 mm	118,-			
	GR-77-NXX	Düsen-/Nadel-Set / Nozzle-/Needle-Set - 1.2/1.5/2.0/2.5/3.0 mm	32,-			
	GR-77-CXX	Luftkappe / AirCap - 1.2/1.5/2.0/2.5/3.0 mm	29,-			
2	G-SET-RT-77	Luftpistolen-Drucktank-Set Drucktank 2 Ltr., Schlauchpaket 1/4" - 2,5 m, Luftpistole GR77 Air Gun Pressure Tank Set Pressure Tank 2 ltr., Hose Set 1/4" - 2,5 m, Air Gun GR77	309,-			

Zubehör auf Seite 94/95
Accessories on page 94/95

Zubehör auf Seite 94/95
Accessories on page 94/95



1 PRONA
R-103



2 PRONA
R-203



3 PRONA
R-403



4 PRONA
R-403-PI

5 CUP
600ml

PRONA

Pos.	Art.-Nr. Part-No.	Artikelbeschreibung Description	Listenpreis List price	Netto-Stückpreis bei Net unit price for		
			€/Stück €/piece	1 Stück 1 piece	5 Stück 5 pieces	10 Stück 10 pieces
R-103						
1	R-103P-XX	Luftpistole mit Düse / Air Gun with Tip - 0.8/1.0/1.3/1.5 mm	139,-			
	R-103-NXX	Düsen-/Nadel-Set / Nozzle-/Needle-Set - 0.8/1.0/1.3/1.5 mm	39,-			
	R-103-C-E2P	Luftkappe / AirCap - 0.8-1.5 mm - E2P				
R-203						
2	R-203P-XX	Luftpistole mit Düse / Air Gun with Tip 0.8/1.0/1.2/1.5/1.8/2.0/2.5 mm	149,-			
	R-203-NXX	Düsen-/Nadel-Set / Nozzle-/Needle-Set 0.8/1.0/1.2/1.5/1.8/2.0/2.5 mm	48,-			
	R-203-CXX	Luftkappe / AirCap - 0.8/1.0/1.2/1.5/1.8/2.0/2.5 mm - G2P/K1/K2/R2/W2				
R-403						
3	R-403-G-XX	Luftpistole mit Düse / Air Gun with Tip 1.2/1.4/1.6/1.8/2.0/2.5 mm	169,-			
4	R-403-G-PI-XX	Luftpistole mit Düse und Druckbecher Air Gun with Tip and pressure assisted hopper 1.2/1.4/1.6/1.8/2.0/2.5 mm	189,-			
	R-403-NXX	Düsen-/Nadel-Set / Nozzle-/Needle-Set 1.2/1.4/1.6/1.8/2.0/2.5 mm	48,-			
	R-403-CXX	Luftkappe / AirCap - 1.2/1.4/1.6/1.8/2.0/2.5 mm - LV2/K2/R2/W2	48,-			
5	RC-6M-P	Druckbecher - 600ml Pressure Assisted Hopper - 600ml	29,-			

NEW. R-413. HVLP.

1 R-413

- Beste ergonomische Bauform
- Abzugsbügel & Düsen/Nadeln aus Edelstahl
- HVLP Düsensystem 1.2/1.3/1.4/1.5/1.6/1.8/2.0/2.5 mm
- Bestes Preis-Leistungs-Verhältnis
- Best ergonomic construction
- Trigger & nozzle/needle made of stainless steel
- HVLP nozzle-system 1.2/1.3/1.4/1.5/1.6/1.8/2.0/2.5 mm
- Best price-performance ratio



PRONA R-413

Art.-Nr. Part-No.	Artikelbeschreibung Description	Listenpreis List price	Netto-Stückpreis bei Net unit price for		
			5 Stück 5 pieces	10 Stück 10 pieces	100 Stück 100 pieces
R-413-G-XX	Luftpistole mit Düse / Air Gun with Tip - 1.2/1.3/1.4/1.5/1.6/1.8/2.0/2.5 mm	99,-			
	Mindestabnahme: 5 Stk. Minimum Order Quantity: 5 Pcs.				
		€/Stück €/piece	1 Stück 1 piece	10 Stück 10 pieces	20 Stück 20 pieces
R-413-N-XX	Düsen-/Nadel-Set / Nozzle-/Needle-Set - 1.2/1.3/1.4/1.5/1.6/1.8/2.0/2.5 mm	33,-			
R-413-C-XX	Luftkappe / AirCap - 1.2/1.3/1.4/1.5/1.6/1.8/2.0/2.5 mm - LV2/W2	29,-			
R-413-SET	Reparatur-Set / Fixing-Set	22,-			

LOW PRESSURE. AIR. AUTOMATIC.

Detaillierte
Technische Informationen
und weitere Modelle finden
Sie im separaten Katalog

Find detailed
technical information
and further Products in
separate catalogue

Umfangreiches Sortiment:

- Universal
- Niederdruck
- HVLP
- Miniatur

Eigenschaften:

- Regelbare Luftzufuhr, Spritzstrahlbreite und Materialsteuerung
- Materialführende Teile in Edelstahl
- Breites Düsensortiment

Wide range of Automatic Guns:

- Universal
- Low Pressure
- High Capacity
- Miniature

Characteristics:

- Adjustable Air Intake, Spray Pattern width, coating output
- Parts in contact with material are made out of Stainless Steel
- Various fluid nozzles available



1 RAR-50A



Universal



Precise

HVLP RAR

Pos.	Art.-Nr. Part-No.	Artikelbeschreibung Description	Listenpreis	Netto-Stückpreis bei		
			List price	Net unit price for		
			€/Stück €/piece	1 Stück 1 piece	5 Stück 5 pieces	10 Stück 10 pieces
1	RAR-50A-XX	Automatik Luftpistole mit Düse / Automatic Air Gun with Tip - 0.4/0.6/1.0/1.2 mm	345,-			

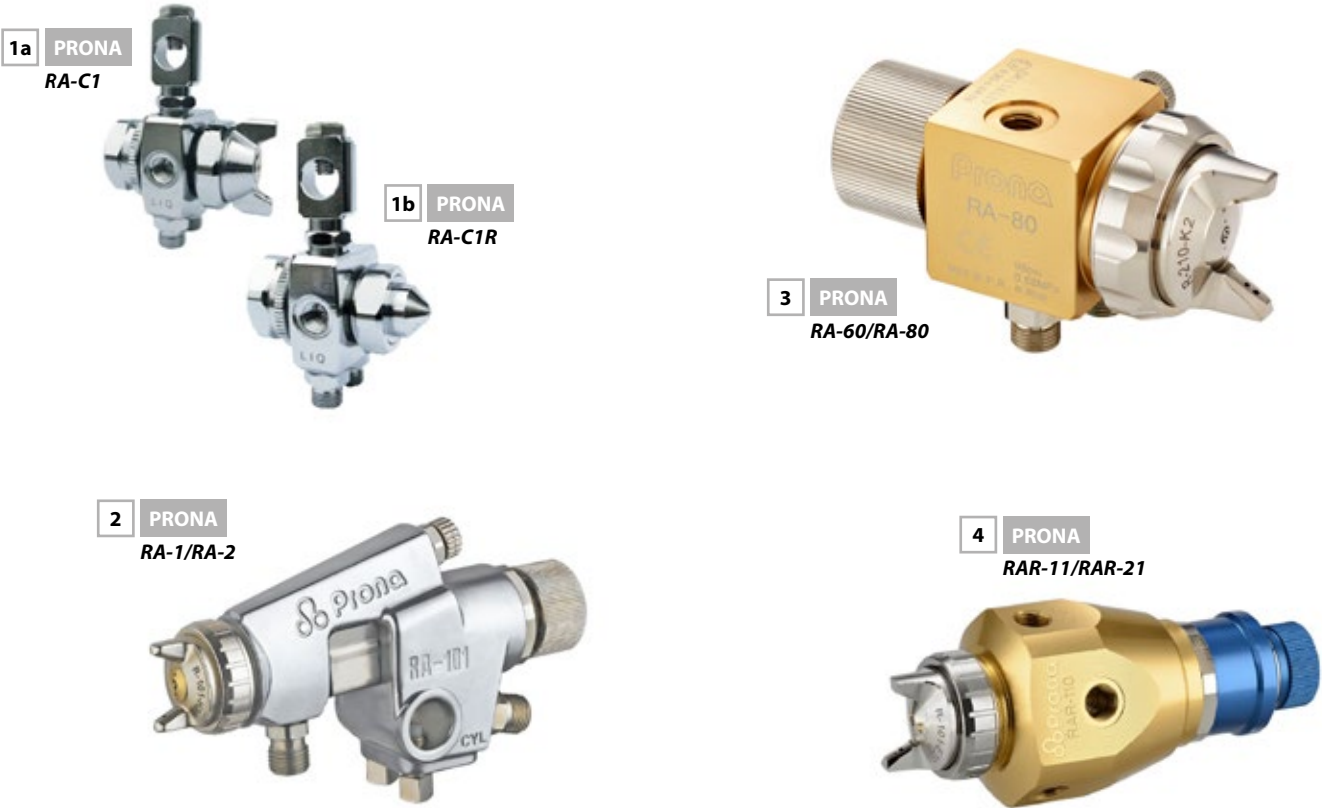

Automatik Luftpistolen / Automatic Air Guns

Pos.	Art.-Nr. Part-No.	Artikelbeschreibung Description	Listenpreis List price	Netto-Stückpreis bei Net unit price for		
			€/Stück €/piece	1 Stück 1 piece	5 Stück 5 pieces	10 Stück 10 pieces

MINI RA-C1 / RA-C1R

1a	RA-C1-XX	Pistole mit Flachstrahldüse / Gun with Flat Jet Tip - 0.5/1.0/1.3/2.0 mm	99,-			
1b	RA-C1R-XX	Pistole mit Rundstrahl Düse / Gun with Round Jet Tip - 0.5/1.0/1.3/2.0 mm				

UNIVERSAL RA-1 / RA-2

2	RA-1-XX	Pistole mit Düse / Gun with Tip - 0.8/1.0/1.3/1.5/1.8 mm	289,-			
	RA-1-NXX	Düsen-/Nadel-Set / Nozzle-/Needle-Set - 0.8/1.0/1.3/1.5/1.8 mm	48,-			
	RA-1-CXX	Luftkappe / AirCap - 0.8/1.0/1.3/1.5/1.8 mm - E2P / H2 / N2	48,-			
	RA-2-XX	Pistole mit Düse / Gun with Tip - 1.2/1.5/1.8/2.0/2.5 mm	310,-			
	RA-2-NXX	Düsen-/Nadel-Set / Nozzle-/Needle-Set - 1.2/1.5/1.8/2.0/2.5 mm	48,-			
	RA-2-CXX	Luftkappe / AirCap - 1.2/1.5/1.8/2.0/2.5 mm - G2P / K2 / R2 / W2	48,-			

UNIVERSAL RA-60 / RA-80

3	RA-60-XX	Pistole mit Düse / Gun with Tip - 0.8/1.0/1.3/1.5/1.8 mm	149,-			
	RA-80-XX	Pistole mit Düse / Gun with Tip - 1.2/1.5/1.8/2.0/2.5 mm	178,-			

HVLP RAR-11 / RAR-21

4	RAR-11-XX	Pistole mit Düse / Gun with Tip - 0.8/1.0/1.3/1.5/1.8 mm	299,-			
	RAR-11-NXX	Düsen-/Nadel-Set / Nozzle-/Needle-Set - 0.8/1.0/1.3/1.5/1.8 mm	56,-			
	RAR-11-CXX	Luftkappe / AirCap - 0.8/1.0/1.3/1.5/1.8 mm - E2P / H2 / N2	56,-			
	RAR-21-XX	Pistole mit Düse / Gun with Tip - 0.8/1.0/1.2/1.5/1.8/2.0/2.5 mm	345,-			
	RAR-21-NXX	Düsen-/Nadel-Set / Nozzle-/Needle-Set - 0.8/1.0/1.2/1.5/1.8/2.0/2.5 mm	56,-			
	RAR-21-CXX	Luftkappe / AirCap - 0.8/1.0/1.2/1.5/1.8/2.0/2.5 mm - C21 / G2P / K2 / R2 / W2	56,-			

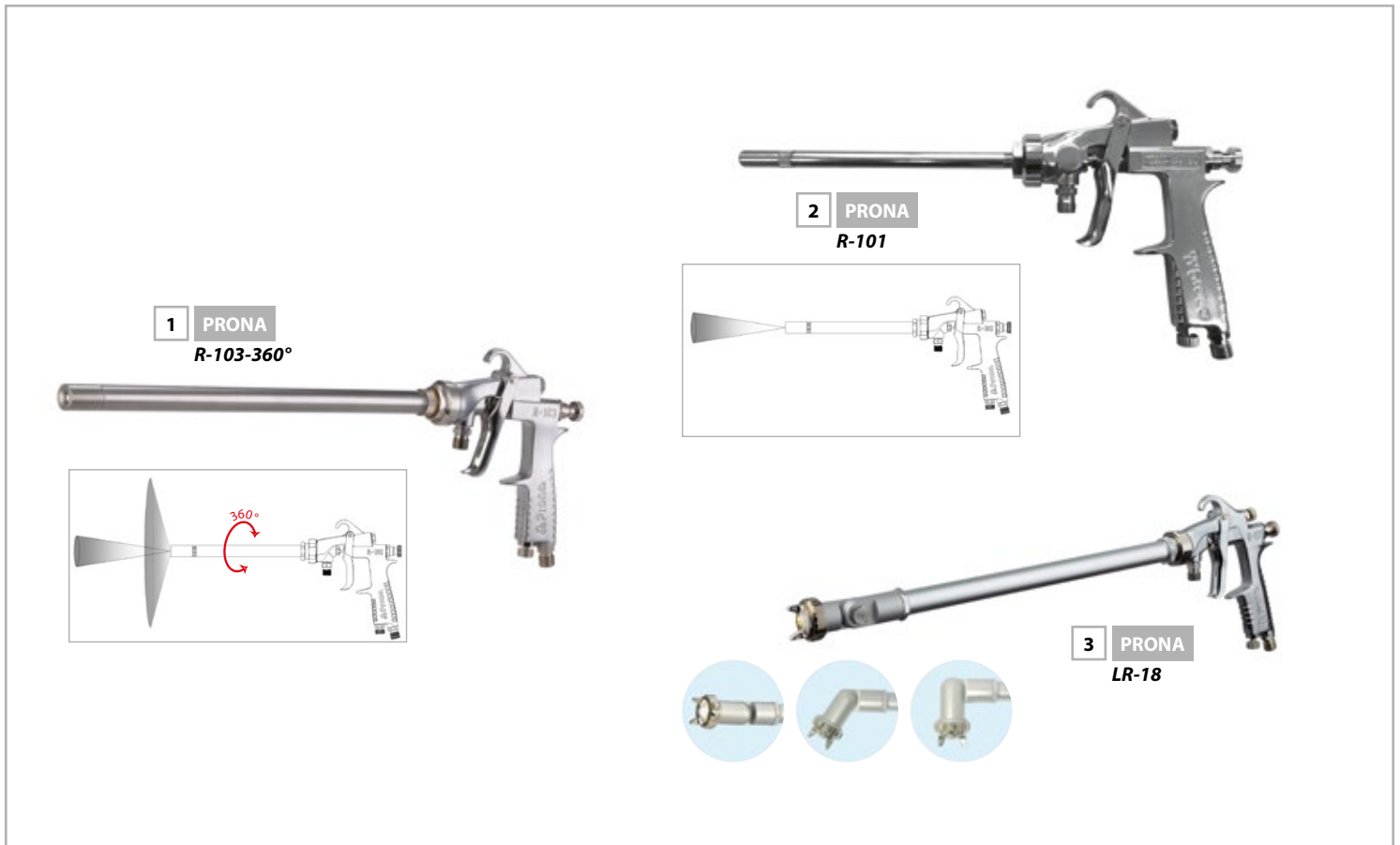

Innenbeschichtungspistolen / Inner wall Spray Guns

Pos.	Art.-Nr. Part-No.	Artikelbeschreibung Description	Listenpreis List price	Netto-Stückpreis bei Net unit price for		
			€/Stück €/piece	1 Stück 1 piece	3 Stück 3 pieces	5 Stück 5 pieces
PRONA R-103 360°						
1	R-103-360-50	Luftpistole mit Verlängerung 50 cm - 360° Air Gun with Extension 50 cm - 360°	590,-			
PRONA R-101 mit Verlängerung / with Extension						
2	R-101-15	Luftpistole mit Verlängerung / Air Gun with Extension - 15 cm	298,-			
	R-101-30	Luftpistole mit Verlängerung / Air Gun with Extension - 30 cm				
	R-101-15-T	Verlängerung / Extension - 15 cm	202,-			
	R-101-30-T	Verlängerung / Extension - 30 cm				
	R-101-80-T	Verlängerung / Extension - 80 cm		225,-		
PRONA LR-18 mit Verlängerung und Kniegelenk / with Extension and Angle Head						
3	LR-18-15	Pistole mit Verlängerung 15 cm - Kniegelenk 0-180° - 1.0 mm Gun with Extension 15 cm - Angle Head 0-180° - 1.0 mm	298,-			
	LR-18-15-P13	Luftkappen-/Düsen-/Nadel-set / Air Cap/Nozzle/Needle-Set - 1.3 mm	225,-			
	LR-18-15-P15	Luftkappen-/Düsen-/Nadel-set / Air Cap/Nozzle/Needle-Set - 1.5 mm				
	LR-18-30	Pistole mit Verlängerung 30 cm - Kniegelenk 0-180° - 1.0 mm Gun with Extension 30 cm - Angle Head 0-180° - 1.0 mm	339,-			
	LR-18-30-P13	Luftkappen-/Düsen-/Nadel-set / Air Cap/Nozzle/Needle-Set - 1.3 mm	225,-			
	LR-18-30-P15	Luftkappen-/Düsen-/Nadel-set / Air Cap/Nozzle/Needle-Set - 1.5 mm				



Spezialpistolen / Special Guns

Pos.	Art.-Nr. Part-No.	Artikelbeschreibung Description	Listenpreis	Netto-Stückpreis bei		
			List price	Net unit price for		
			€/Stück €/piece	1 Stück 1 piece	5 Stück 5 pieces	10 Stück 10 pieces

Ausblaspistole / Blowing Spray Gun

1	RG-7-1	ohne Verlängerung / without Extension	9,90			
2	RG-7-4	mit Verlängerung / with Extension	12,90			

Trennmittelpistolen / Mold Release Guns

3	MRS-F	MRS für Flachstrahldüsen / for flat jet tips	138,-			
	MRS-R/F-XX	Düsen-/Nadel-Set / Tip-/Needle-set - 0.3/0.5/0.8 mm	38,-			
	MRS-F1-XX	Luftkappe Flachstrahl / Aircap flat jet - 0.3/0.5/0.8 mm	29,-			

3	MRS-R	MRS für Rundstrahldüsen / for round jet tips	138,-			
	MRS-R/F-XX	Düsen-/Nadel-Set / Tip-/Needle-set - 0.3/0.5/0.8 mm	38,-			
	MRS-R1-XX	Luftkappe Rundstrahl / Aircap round jet - 0.3/0.5/0.8 mm	29,-			

Kleberpistole / Glue Gun

4	F-12-P	Basispistole mit Griffschutz - ohne Düse Basic gun with handle protection - without tip	118,-			
5	F-12-L-P	Basispistole mit Verlängerung 45 cm und Griffschutz - ohne Düse Basic gun with extension 45 cm and handle protection - without tip	156,-			

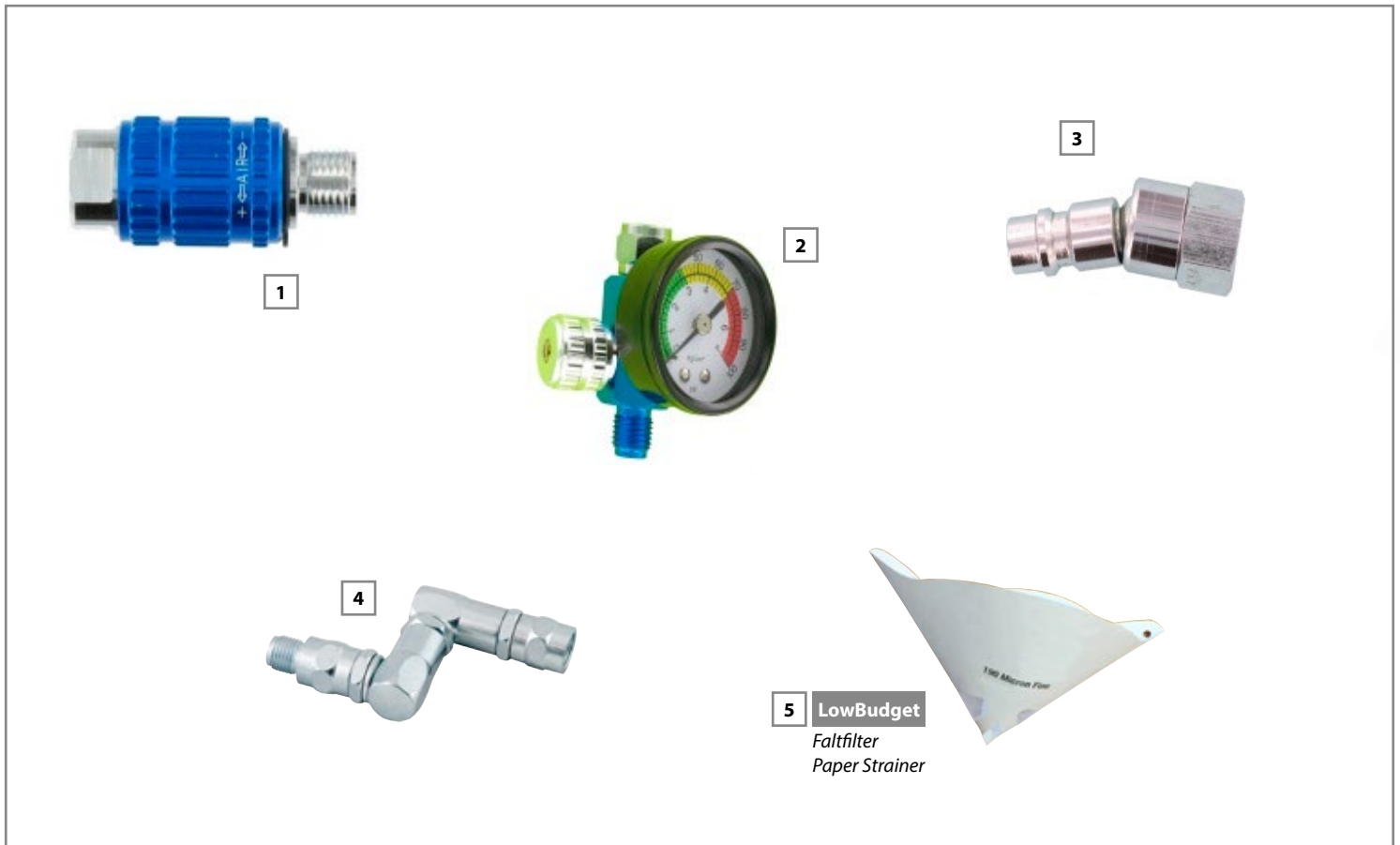

Pos.	Art.-Nr. Part-No.	Artikelbeschreibung Description	Listenpreis List price	Netto-Stückpreis bei Net unit price for		
			€/Stück €/piece	1 Stück 1 piece	10 Stück 10 pieces	25 Stück 25 pieces
Luft / Air						
1	JF-1/4	Luftregelventil / Air flow control valve - 1/4"	9,80			
2	LM-50-NEW	Luftregelventil mit Manometer - 1/4" - Edelstahlgehäuse Air flow control valve with Gauge- 1/4" - Stainless steel housing	19,80			
	LM-50-LB	Luftregelventil mit Manometer - 1/4" - LowBudget Air flow control valve with Gauge- 1/4" - LowBudget	15,80			
3	LT-331	Schnellkupplung / Quick coupling - 360° - 1/4" (F)	10,80			
	LT-330	Schnellkupplung / Quick coupling - 360° - 1/4" (M)				
Z-Drehgelenk / Z-Swivel						
4	LT-1Z	Kupplung verzinkt, 3-fach drehbar - 1/4" (M) x 1/4" (F) Coupling Zinc-plated, triple swivel, 1/4" (M) x 1/4" (F)	59,00			
Faltfilter / Paper Strainer						
5	PAPER-FI-125-LB	125 µ (1.000 Stück / pieces)	72,00	1 Stück 1 piece	5 Stück 5 pieces	10 Stück 10 pieces
	PAPER-FI-190-LB	190 µ (1.000 Stück / pieces)				

Aluminium Fließbecher und Saugbecher, sowie weitere Anschlussgewinde auf Anfrage
 Aluminium gravity cups and suction cups, as well as further threadings on request



1 LowBudget
600 ml



3 LowBudget
Passend / Fitting
Fließbecher
Gravity Cup



2 LowBudget
1000 ml



4 LowBudget
Passend / Fitting
Saugbecher
Suction Cup
Ø 19 mm



5 LowBudget
Passend / Fitting
Saugbecher
Suction Cup
Ø 29 mm

Pos.	Art.-Nr. Part-No.	Artikelbeschreibung Description	Listenpreis	Netto-Stückpreis bei		
			List price	Net unit price for		
			€/Stück €/piece	1 Stück 1 piece	10 Stück 10 pieces	25 Stück 25 pieces

Fließbecher / Gravity Cups - 600 ml

1	CUP-M16-F	M16x1.5 (F)	16,-			
	CUP-M16-QUICK	M16x1.5 (M) - Schnellkupplung / Quick coupling				
	CUP-3/8-F	3/8" (F)				
	CUP-3/8-M	3/8" (M)				

Saugbecher / Suction Cup - 1000 ml

2	RCL-10B	Bajonett-Verschluss / Bayonet Lock - 3/8" (F)	34,-			
---	---------	---	------	--	--	--

Filter

			€/Stück €/piece	10 Stück 10 pieces	50 Stück 50 pieces	100 Stück 100 pieces
3	35155-60-NY-LB	60 Maschen - Nylon / 60 mesh - Nylon	1,50			
	35155-60-SS-LB	60 Maschen - Edelstahl / 60 mesh - Stainless Steel				
	35155-100-NY-LB	100 Maschen - Nylon / 100 mesh - Nylon				
	35155-100-SS-LB	100 Maschen - Edelstahl / 100 mesh - Stainless Steel				
4	35166-100-NY-LB	100 Maschen - Nylon / 100 mesh - Nylon - D19	1,80			
	35166-100-SS-LB	100 Maschen - Edelstahl / 100 mesh - Stainless Steel - D19				
5	3517700-NY-LB	130 Maschen - Nylon / 130 mesh - Nylon - D29	1,80			
	3517700-SS-LB	130 Maschen - Edelstahl / 130 mesh - Stainless Steel - D29	2,-			



Pos.	Art.-Nr. Part-No.	Artikelbeschreibung Description	Listenpreis	Netto-Stückpreis bei		
			List price	Net unit price for		
			€/Stück €/piece	1 Stück 1 piece	12 Stück 12 pieces	24 Stück 24 pieces

Reinigungsnadeln / Cleaning Broaches

1	DRN-10/29	D10 L29 (12 Stück / 12 pieces)	9,90			
2	B-NS6	Ring mit 6 Nadeln / Ring with 6 broaches	2,50			

Reinigungsbohrer / Cleaning Drills

			€/Stück €/piece	1 Stück 1 piece	10 Stück 10 pieces	20 Stück 20 pieces
3	DRN-70/25	L25 (6 Stück / 6 pieces)	25,-			

Düsenreinigung / TIP-Cleaning

			€/Stück €/piece	1 Stück 1 piece	12 Stück 12 pieces	24 Stück 24 pieces
4	TC-B50	TIP-Clean, ohne Flüssigkeit / without liquid - 50 ml	6,60			
5	TC-B200	TIP-Clean, ohne Flüssigkeit / without liquid - 200 ml	10,90			
6	TC200	TIP-Clean - 200 ml	14,20			
7	TC1000	Reinigungslösung / Cleaning liquid - 1000 ml	18,80			
8	TC50	TIP-Clean - 50 ml	7,90			

1
12 teilig
12 parts



2
17 teilig
17 parts

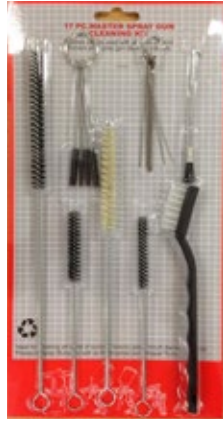

3



4



5

6

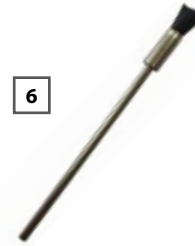

Pos.	Art.-Nr. Part-No.	Artikelbeschreibung Description	Listenpreis List price	Netto-Stückpreis bei Net unit price for		
			€/Stück €/piece	1 Stück 1 piece	10 Stück 10 pieces	20 Stück 20 pieces
Bürsten / Brushes						
1	BR-SET12	Bürstenreinigungs-Set 12 teilig Brush cleaning set 12 parts	12,90			
2	BR-SET17	Bürstenreinigungs-Set 17 teilig Brush cleaning set 17 parts	19,90			
3	B-SB5	Bürstenreinigungs-Set 5 teilig Brush cleaning set 5 parts	6,90			
	B-SB5-LB	Bürstenreinigungs-Set 5 teilig - LowBudget Brush cleaning set 5 parts - LowBudget	5,90			
4	B-001	Reinigungsbürste / Cleaning brush	3,90			
5	B-10	Reinigungsbürste - 300 mm - 100 mm - 15 mm Cleaning brush - 300 mm - 100 mm - 15 mm	2,50			
	B-11	Reinigungsbürste - 155 mm - 55 mm - 10 mm Cleaning brush - 155 mm - 55 mm - 10 mm				
	B-12	Reinigungsbürste - 230 mm - 80 mm - 12 mm Cleaning brush - 230 mm - 80 mm - 12 mm				
	B-13	Reinigungsbürste - 155 mm - 55 mm - 10 mm - konisch Cleaning brush - 155 mm - 55 mm - 10 mm - conical				
6	B-14	Reinigungspinsel / Cleaning brush	2,50			

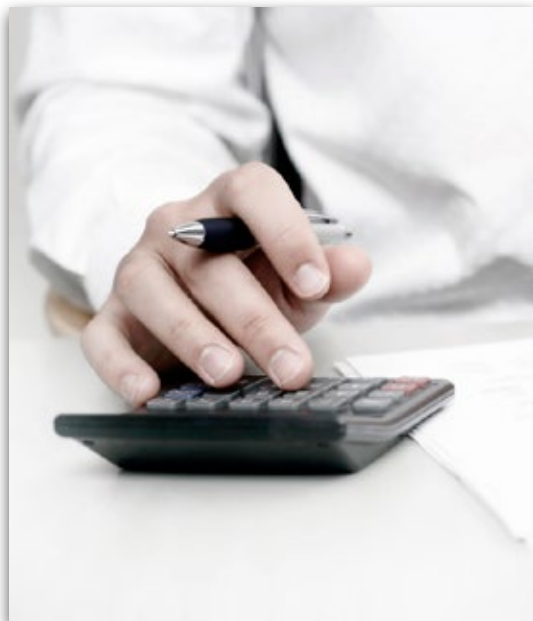

Liefer- und Zahlungsbedingungen

Preise:	Gültig ab 01.02.2019 zuzüglich ges. MwSt.
Lieferung:	Ab Werk zuzüglich Versandkosten
Lieferservice:	Auf Wunsch versenden wir Ihre Bestellungen neutral oder mit Ihren Versandunterlagen direkt an Ihren Kunden
Mindestbestellwert:	Unter 50,00 € - Zuschlag 10,00 € netto
Zahlung:	Nach Vereinbarung
Rücksendung:	Die ohne unser Verschulden erfolgen, stellen wir 20% des Warenwertes für Abwicklung, Wiedereinlagerung in Rechnung

**Wir liefern Zubehör- und Ersatzteile für alle gängigen Marken.
Gerne unterbreiten wir Ihnen auf Anfrage unsere Angebote.**

Kein Vertrieb der Handelsmarke Airless nach Frankreich.
Es gelten unsere allgemeinen Verkaufs- und Lieferbedingungen.

Technische Änderungen bleiben uns vorbehalten.

Terms and Conditions of Delivery and Payment

<i>Prices:</i>	<i>Valid from 01.02.2019 additionally VAT</i>
<i>Delivery:</i>	<i>Ex works plus forwarding charges</i>
<i>Delivery-Service:</i>	<i>If desired we deliver your order neutral or with your shipping documents directly to your cus- tomer</i>
<i>Minimum order value:</i>	<i>Below 50,00 € - Surcharge 10,00 € net</i>
<i>Payment:</i>	<i>By agreement</i>
<i>Returns:</i>	<i>Returns which are independent of our negli- gence, we charge 20% of the merchandise value for transaction and backsourcing</i>

**We deliver accessories and spare-parts for all established brands.
We have much pleasure to submit you our quotation.**

*No sales of the Trademark Airless to France.
Our general sales terms and delivery conditions apply.*

Subject to change of technical data and information without notice.



Gemini GmbH
Rheinstraße 7
88046 Friedrichshafen
Germany

Tel.: +49 (0)7541/98 156-15
Fax: +49 (0)7541/98 156-25
E-Mail: info@gemini-airless.de
Web: www.gemini-airless.de